

A Discrete Approach to the Poincaré-Miranda Theorem

Connor Ahlbach

Francis Su, Advisor

Michael Orrison, Reader

May, 2013

HARVEY MUDD
COLLEGE

Department of Mathematics

Copyright © 2013 Connor Ahlback.

The author grants Harvey Mudd College the nonexclusive right to make this work available for noncommercial, educational purposes, provided that this copyright statement appears on the reproduced materials and notice is given that the copying is by permission of the author. To disseminate otherwise or to republish requires written permission from the author.

Abstract

The Poincaré-Miranda Theorem is a topological result about the existence of a zero of a function under particular boundary conditions. In this thesis, we explore proofs of the Poincaré-Miranda Theorem that are discrete in nature - that is, they prove a continuous result using an intermediate lemma about discrete objects. We explain a proof by Tkacz and Turzański that proves the Poincaré-Miranda Theorem via the Steinhaus Chessboard Theorem, involving colorings of partitions of n -dimensional cubes. Then, we develop another new proof that relies on a polytopal generalization of Sperner's Lemma of DeLoera - Peterson - Su. Finally, we extend these discrete ideas to prove the existence of a zero with the boundary condition of Morales, in dimension 2.

Contents

Abstract	iii
1 Introduction	1
1.1 Overview	1
1.2 Background	1
1.3 Layout	5
2 Sperner's Lemma and Brouwer Fixed Point Theorem	7
2.1 Background	7
2.2 Sperner's Lemma	10
2.3 Proving the Brouwer Fixed Point Theorem with Sperner's Lemma	13
3 The Steinhaus Chessboard Theorem	17
3.1 Background and Setup	17
3.2 Proving the Steinhaus Chessboard Theorem	22
3.3 Proving the Poincaré-Miranda Theorem with the Steinhaus Chessboard Theorem	28
4 Polytopal Sperner's Lemma	31
4.1 Polytopal Sperner's Lemma	31
4.2 Proving the Poincaré-Miranda Theorem with Polytopal Sperner's Lemma	33

5	Another Zero Theorem	37
5.1	Morales's Generalization of the Intermediate Value Theorem	37
5.2	Discrete Proof in Dimension 2	38
6	Conclusion	45
	Bibliography	47

Chapter 1

Introduction

1.1 Overview

In this thesis, we study the Poincaré-Miranda Theorem (Poincaré (1886), Miranda (1940)). First, we motivate the significance of the Poincaré-Miranda Theorem as an n -dimensional generalization of the Intermediate Value Theorem. We describe and discuss the advantages of discrete approaches to topological results, such as the Poincaré-Miranda Theorem, and exemplify this approach by proving the Brouwer Fixed Point Theorem using Sperner's Lemma. Next, we describe Tkacz's and Turzański's discrete approach to the Poincaré-Miranda Theorem, which involves proving the existence of a particular connected chain of cubes. We then explore an original discrete proof of the Poincaré-Miranda Theorem using a generalization of Sperner's Lemma to polytopes. Finally, we investigate another theorem guaranteeing the existence of a zero of a function and prove a special case.

1.2 Background

Let $I = [0, 1]$. We can state the Bolzano Intermediate Value Theorem as follows:

Theorem 1 (Intermediate Value). *If $f : I \rightarrow \mathbb{R}$ is continuous,*

$$f(0) < 0, \quad \text{and} \quad f(1) > 0, \tag{1.1}$$

then there exists $x \in I$ such that $f(x) = 0$.

2 Introduction

We visualize the Intermediate Value Theorem in Figure 1.1:



Figure 1.1 Any continuous function on a line segment that is negative on one endpoint and positive on the other endpoint must have a zero.

This classical result follows easily from the fact that continuous functions preserve connectedness. Can we generalize Theorem 1 to higher dimensions?

Suppose $f : I^n \rightarrow \mathbb{R}^n$ is continuous. What conditions, if any, for f on the boundary of I^n would guarantee the existence of a zero of f ? For $n = 1$, Theorem 1 tells us that condition 1.1 will guarantee the existence of a zero. In n dimensions, the general question is answered by the Poincaré-Miranda Theorem.

Before we state the Poincaré-Miranda Theorem, we will need some notation. Let x_i denote the i -th coordinate of $x \in \mathbb{R}^n$. Then, we denote the i -th opposite faces of I^n by

$$I_i^- = \{x \in I^n \mid x_i = 0\}, \quad I_i^+ = \{x \in I^n \mid x_i = 1\}.$$

In this paper, n will always represent the dimension of the cube. We visualize these opposite faces in Figure 1.2 for $n = 1, 2, 3$:

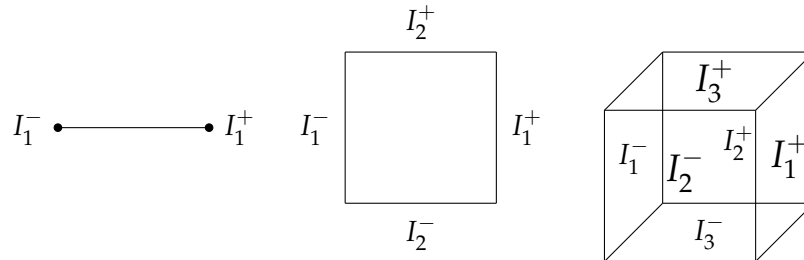

Figure 1.2 The opposite sides of the n -cube for $n = 1, 2, 3$.

We state the Poincaré-Miranda Theorem (Poincaré (1886), Miranda (1940)).

Theorem 2 (Poincaré-Miranda). *Suppose $f = (f_1, \dots, f_n) : I^n \rightarrow \mathbb{R}^n$ is continuous and*

$$f_i(I_i^-) \subset (-\infty, 0), \quad f_i(I_i^+) \subset (0, \infty). \quad (1.2)$$

Then, there exists $x \in I^n$ such that $f(x) = 0$.

The main significance of the Poincaré-Miranda Theorem is its ability to guarantee the existence of a zero of a function without having to solve for one explicitly. It can be used in more than 1 dimension unlike Theorem 1.

If f satisfies condition 1.2, f takes on opposite signs in the i -th coordinate on the i -th opposite sides. In particular,

$$f_i < 0 \text{ on } I_i^-, \quad f_i > 0 \text{ on } I_i^+.$$

We visualize condition 1.2 for $n = 1, 2$ in Figure 1.3:

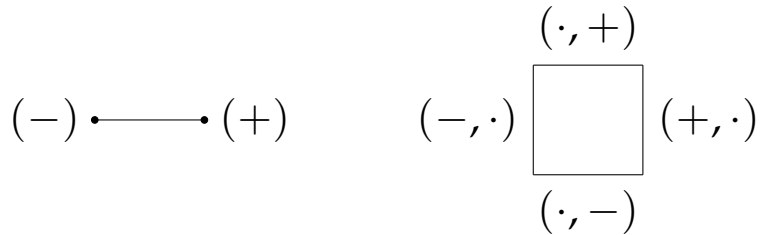

Figure 1.3 The boundary conditions of the Poincaré-Miranda Theorem for $n = 1, 2$.

Let us give some examples so that we can see why Theorem 2 is a reasonable guess for a generalization of Theorem 1.

1. If $n = 1$, Theorem 2 reduces to Theorem 1. Thus, the Poincaré-Miranda Theorem generalizes the Intermediate Value Theorem.
2. If f_i depends only on x_i , then we can write

$$f(x_1, \dots, x_i, \dots, x_n) = (f_1(x_1), \dots, f_i(x_i), \dots, f_n(x_n))$$

where each f_i is a continuous function of 1 variable. From Equation 1.2, we have

$$f_i(0) < 0, \quad f_i(1) > 0.$$

Then, there exists $p_i \in I$ such that $f_i(p_i) = 0$, meaning that $f(p_1, \dots, p_n) = 0$, proving the existence of a zero of f .

3. Consider $f : I^2 \rightarrow \mathbb{R}^2$ given by

$$f(x, y) = (x + y - 1, y - x).$$

It is easy to see that f satisfies condition 1.2. The zeros of f occurs at the solution(s) to the system

$$x + y = 1, \quad y = x,$$

which can easily be solved to get the zero $(\frac{1}{2}, \frac{1}{2}) \in I^n$.

4. Of course, not all instances of Theorem 2 follow directly from Theorem 1, or have a 0 that can be solved algebraically. For example, consider $f : I^2 \rightarrow \mathbb{R}^2$ given by

$$f(x, y) = \left(\sin x + \cos y + 2(x - 1), y - \frac{1}{2} \left(x - \frac{1}{2} \right)^2 + \frac{1}{2} \right).$$

Here, f satisfies condition 1.2, but the existence of a 0 does not follow easily from Theorem 1, and one cannot solve for a 0 using algebraic techniques.

However, the simple connectivity argument used to prove Theorem 1 fails for general n . Of course, Theorem 2 has been established, and multiple proofs are known. The original proof by Poincaré in 1886 used homotopy invariance (Poincaré (1886)). In 1940, Miranda showed that the Poincaré-Miranda Theorem is equivalent to the Brouwer Fixed Point Theorem (Miranda (1940)). The Brouwer Fixed Point Theorem which was established in general by Hadamard in 1910 (Hadamard (1910)).

We next introduce the Brouwer Fixed Point Theorem, which will be relevant to our discussion, especially in Chapter 2. Let $\mathcal{B}^n = \{x \in \mathbb{R}^n \mid \sum_{i=1}^n x_i^2 \leq 1\}$ be the n -dimensional ball. Recall that a fixed point of a function f is a point x such that $f(x) = x$.

Theorem 3 (Brouwer Fixed Point). *Every continuous map $f : \mathcal{B}^n \rightarrow \mathcal{B}^n$ has a fixed point.*

The proof of Theorem 3 using Sperner's Lemma is well-known. Sperner's Lemma was established by Sperner in 1928 (Sperner (1928)), but it was Knaster, K. Kuratowski, and S. Mazurkiewicz who used it to prove Theorem 3 (Knaster et al. (1929)). This proof exemplifies a discrete approach

to a topological result. First, one proves an intermediary discrete result or analog (in this case Sperner's Lemma), and then uses it to prove the theorem (in this case the Brouwer Fixed Point Theorem). This discrete approach has some advantages. First, the intermediate discrete analog is often easier to prove, or at least requires less sophisticated techniques, than the topological result. This approach tends to avoid higher-level concepts, like in this case degree or homology, that more advanced proofs use, making them more accessible to less experienced mathematicians. Then, if our discrete analog was chosen wisely, the topological result follows easily. We are breaking the problem into two parts, both simpler than the whole. Furthermore, the discrete analog may be remarkable in and of itself. Finally, discrete proofs can be, to some extent, constructive. So, for example, Sperner's Lemma, which proves the Brouwer Fixed Point Theorem, does give us an idea where the fixed point is.

Since Theorem 2 and Theorem 3 are equivalent (Miranda (1940)), and there is a discrete proof for Theorem 3, analogously, shouldn't there be an discrete proof for Theorem 2?

Yes! In fact, I have found two papers with such approaches, and found an original proof as well (Kulpa (1997), Tkacz and Turzański (2008)) .

In his paper on the Poincaré-Miranda Theorem, Kulpa proves Theorem 2 by constructing a labelling on the cube, proving a variation, but not a generalization, of Sperner's Lemma, and finally using it to prove Theorem 2 (Kulpa (1997)). In fact, we will prove Theorem 2 using a generalization of Sperner's Lemma to polytopes. It makes sense that such similarity is found to Sperner's Lemma because Theorem 2 and Theorem 3 are equivalent. Also, in their paper on the Steinhaus Chessboard Theorem, Tkacz and Turzański also prove a discrete result about colorings on partitions of cubes first and then use it to prove Theorem 2 (Tkacz and Turzański (2008)).

1.3 Layout

In Chapter 2, we give an example of how discrete approaches to topological results work by proving Sperner's Lemma and using it to prove Theorem 3. Furthermore, the proof of the Brouwer Fixed Point Theorem using Sperner's Lemma is a classical proof mathematicians should know, and it is not a diversion because Sperner's Lemma is quite relevant to our work here. Many of the same ideas that show up in Sperner's Lemma

will show up later. Then, in Chapter 3, we carefully clarify and proceed through Tkacz's and Turzański's proof of Theorem 2 using the Steinhaus Chessboard Theorem. In Chapter 4, we explain an original proof of the Poincaré-Miranda Theorem using a polytopal generalization of Sperner's Lemma. This proof is similar in spirit to Kulpa's (Kulpa (1997)), but its use of a more general labelling and stronger result make it simpler than Kulpa's proof. In Chapter 5, we explore another zero theorem of Morales and give a discrete proof in dimension 2.

Chapter 2

Sperner's Lemma and Brouwer Fixed Point Theorem

2.1 Background

How would one prove a topological result by first proving a discrete analog? In this section, we demonstrate this technique with the proof of the Brouwer Fixed Point Theorem via Sperner's Lemma (Knaster et al. (1929) Sperner (1928)). Note that similar techniques will show up when we present new discrete proofs, so it is well worth discussing this example. To state Sperner's Lemma, we need to define simplices and Sperner labellings. First, let us first go over some background.

Recall that the n -dimensional simplex, or n -simplex, which we denote Δ_n , is the convex hull of $n + 1$ affinely independent points v_1, \dots, v_{n+1} . For $n = 0, 1, 2$, and 3 ,

- Δ_0 is a point.
- Δ_1 is a line segment.
- Δ_2 is a triangle.
- Δ_3 is a tetrahedron.
- See Figure 2.1 for a geometric visualization.

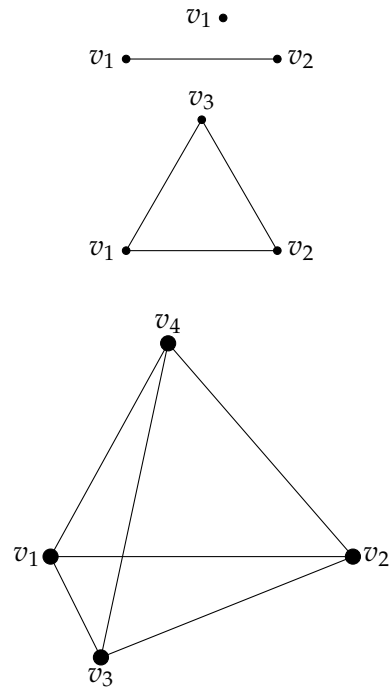

Figure 2.1 From top to bottom: 0-simplex, 1-simplex, 2-simplex, and 3-simplex

Here, in general, we denote the convex hull of x_1, \dots, x_k by $\text{conv}(x_1, \dots, x_k)$. For each $\{i_1, \dots, i_k\} \subset \{1, \dots, (n+1)\}$, we say $\text{conv}(v_{i_1}, \dots, v_{i_k})$ is a face, in particular, a $(k-1)$ -face, of Δ_n . Note that each face of a simplex is also a simplex, of lesser or equal dimension. For notation, let $[k] = \{1, 2, \dots, k\}$ for all $k \in \mathbb{N}$. A triangulation is simply a partition into a finite number of smaller n -simplices where the intersection of 2 simplices is always a face of both simplices. We give an example of a triangulation in Figure 2.2:

Note that triangulations do not allow two simplices to intersect so their intersection is not a face of some simplex. We give an example of intersections that are not allowed in triangulations in Figure 2.3.

Of course, the vertices of triangulation T is simply union of the sets of vertices of each simplex in T . In general, let T be a triangulation of Δ_n into n -simplices, and let $V(T)$ be the set of vertices of T . Now, we have enough background to state Sperner's Lemma.

Definition 1 (Labelling). *A labelling of T is simply a map $L : V(T) \rightarrow [n+1]$,*

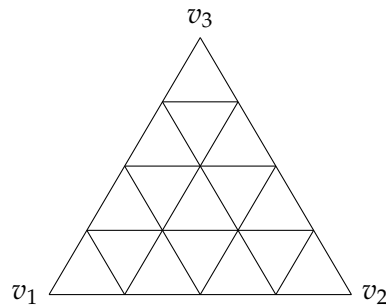

Figure 2.2 An example of a triangulation in dimension 2.

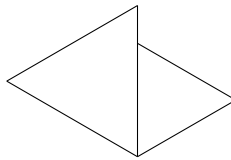

Figure 2.3 Intersections that are not allowed in triangulations

where we say vertex v has label $L(v)$.

Definition 2 (Sperner Labelling). We say L is a Sperner Labelling if the vertices of Δ_n have all the labels 1 through $(n + 1)$, and every vertex belonging to a face F of Δ^n has the same label as one of the vertices of F .

Without loss of generality, we label vertex v_i by i for all $i \in [n + 1]$. In general, to be a Sperner labelling, each vertex in $V(T) \cap \text{conv}(v_{i_1}, \dots, v_{i_k})$ must be labelled one of i_1, i_2, \dots, i_k . For example, with $n = 2$, any Sperner labelling is of the form given in Figure 2.4.

Here, the vertices on face $\text{conv}(v_1, v_2)$ must be labelled 1 or 2, vertices on $\text{conv}(v_2, v_3)$ must be labelled 2 or 3, vertices on $\text{conv}(v_1, v_3)$ must be labelled 1 or 3, and interior vertices can have any label from $\{1, 2, 3\}$. Next, we state and prove Sperner's Lemma, which naturally deals with Sperner labellings (Sperner (1928)). We say that a simplex in T is fully labelled if its vertices have every label in $[n + 1]$.

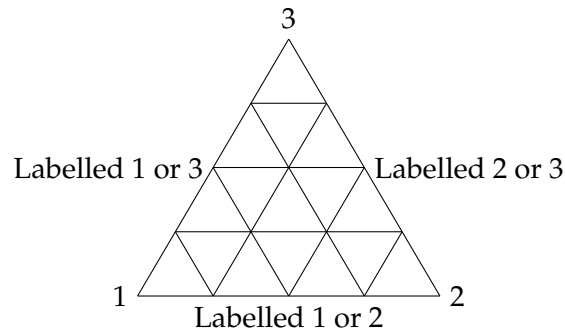

Figure 2.4 Form of a Sperner labelling in dimension 2.

2.2 Sperner's Lemma

Theorem 4 (Sperner's Lemma). *Let T be a triangulation of Δ_n . Then, in every Sperner labelling of T , there exists an odd number of fully labelled simplices in T . In particular, there is at least one fully labelled simplex in T .*

Proof. We prove Theorem 4 by induction on n .

Base Case: Suppose $n = 0$. Then, Δ_0 is a point p . Any Sperner labelling of T must be p labelled with a 1, which yields a fully labelled simplex.

1 •

Induction Hypothesis: Suppose Theorem 4 holds for dimension $n - 1$.

Now, consider Δ_n . Let T be a partition of Δ_n and $L : V(T) \rightarrow [n + 1]$ be any Sperner labelling of T . We refer to the vertices of Δ^n by their label. By restricting L to $\text{conv}(1, 2, \dots, n)$, we get a Sperner labelling of the $(n - 1)$ -face $\text{conv}(1, 2, \dots, n)$. By the induction hypothesis, there exists an odd number of faces on the face $\text{conv}(1, 2, \dots, n)$ with the labels 1 through n . Consider any such face F_0 .

Let a "door" refer to a $(n - 1)$ -face in the triangulation with all the labels $1, 2, \dots, n$. Thus, each such F_0 is a door. Now, construct a path Q of "pebbles" as follows. Start at the simplex S_0 that has F_0 as a face. Put a pebble by face F_0 . Then, if we are in simplex S , and there is a door D in S without a pebble

by it, put one pebble on both sides of D , and move through that face into the next simplex. Continue moving through doors and placing pebbles on both sides of them until there are no unused doors in the simplex we are in. Note that this path must terminate since we can only have a finite number of doors, and we never go through the same door twice.

We have two types of such paths based on where they end. We give an example of each below in dimension 2, where the doors are the 1-faces with vertices labelled 1 and 2.

- Type 1 Paths: The path Q ends in another door on the boundary. If we ever reach another door on the boundary, which must be on the face $\text{conv}(1, 2 \dots n)$ by the fact that we have a Sperner labelling, Q ends.

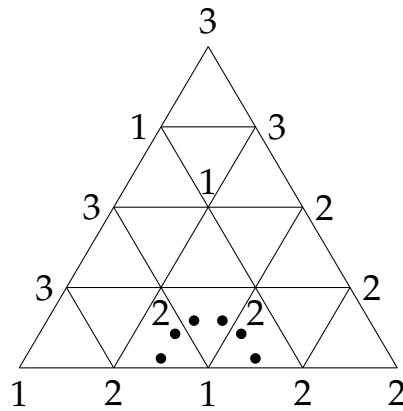

Figure 2.5 Example of a Type 1 Path

- Type 2 Paths: The path Q ends in a fully labelled simplex. Otherwise, if Q does not end in a door on the boundary, it must end somewhere in the interior, as it never goes through a simplex twice and there are a finite number of simplices in T . But, Q can only end in the interior if the simplex it ends in has precisely 1 door, which occurs if and only if Q ends in a fully labelled simplex.

Thus, type 1 paths use exactly 2 doors on the boundary, and type 2 paths use exactly 1 door on the boundary. But by the Inductive Hypthesis, we have an odd number of doors on the boundary, which all must occur on face $\text{conv}(1, 2 \dots n)$. It follows that we must have an odd number of type

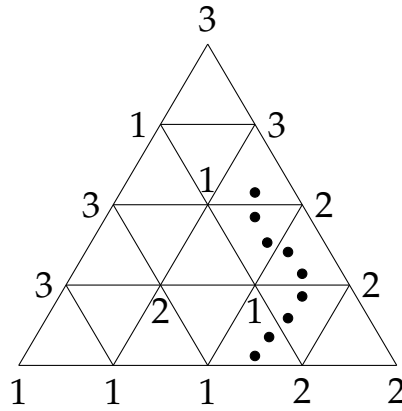

Figure 2.6 Example of a Type 2 Path

2 paths, each giving us one fully labelled simplex. So, the type 2 paths correspond bijectively with an odd number of fully labelled simplices.

However, there may exist other fully labelled simplices in Δ^n which are NOT the end of such a type 2 path of pebbles. Yet, for each of these simplices S , we may again construct paths P using the same technique by starting at S and moving through the doors. We call these type 3 paths. Then, P cannot terminate at a door on the boundary or else S would have been the end of some type 2 path above. By the same argument above, this means that P must terminate in another fully labelled simplex U not hit by a type 1 or type 2 path, because each door belongs to a unique path. And the type 3 path through the doors starting from U reverses P . We illustrate this in Figure 2.7:

Any type 3 path pairs two fully labelled simplices in T that are NOT the end of type 2 paths. Thus, all fully labelled simplices that are not at the end of type 2 paths come in pairs, so there are an even number of them. But an odd number of fully labelled simplices are at the end of type 2 paths, so we conclude that T contains an odd number of fully labelled simplices.

□

This completes the discrete analog part of the proof. We proceed to the topological part.

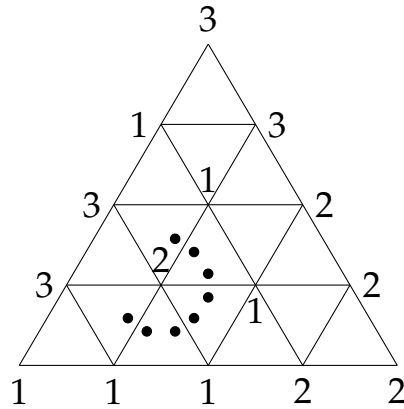

Figure 2.7 Example of a Type 3 Path

2.3 Proving the Brouwer Fixed Point Theorem with Sperner's Lemma

We will use Theorem 4 to prove the No Retraction Theorem, another topological result, and then prove the Brouwer Fixed Point Theorem using the No Retraction Theorem. Next, we define a retract and state the No Retraction Theorem.

Definition 3. For topological spaces $A \subseteq B$, $f : B \rightarrow A$ is a retract if f is continuous and

$$f(a) = a \text{ for all } a \in A. \tag{2.1}$$

Recall that $\mathcal{B}^n = \{x \in \mathbb{R}^n \mid \sum_{i=1}^n x_i^2 \leq 1\}$ is the standard n -dimensional ball, and $\mathcal{S}^{n-1} = \{x \in \mathbb{R}^n \mid \sum_{i=1}^n x_i^2 = 1\}$ is the standard $(n - 1)$ -dimensional sphere. Here, \mathcal{S}^{n-1} is the boundary of \mathcal{B}^n .

Theorem 5 (No Retraction). There does not exist a retract $f : \mathcal{B}^n \rightarrow \mathcal{S}^{n-1}$.

Theorem 5 makes sense because it seems like however we retract the ball to its boundary, the sphere, we would have to rip apart the ball and violate continuity. We now use Theorem 4 to prove the Theorem 5.

Proof. Suppose to the contrary that there exists a retract $f : \mathcal{B}^n \rightarrow \mathcal{S}^{n-1}$. Then, we can deform this to a retract of Δ^n to its boundary $g : \Delta_n \rightarrow \partial\Delta_n$,

because \mathcal{B}^n and Δ^n are homeomorphic topological spaces. Label the vertices of Δ_n by 1 through $(n + 1)$. We refer to these vertices of Δ^n by their label. Let ϵ be half of the distance from the center of each $(n - 1)$ -face $F \neq \text{conv}(1, 2, \dots, n)$ to the face $\text{conv}(1, 2, \dots, n)$ in Δ_n . By symmetry, this minimum distance is the same for each $(n - 1)$ -face $F \neq \text{conv}(1, 2, \dots, n)$.

Let $d : \mathbb{R}^n \times \mathbb{R}^n \rightarrow \mathbb{R}_{\geq 0}$ be the Euclidean metric. Then, by the uniform continuity of f , since Δ^n is compact, there exists $\delta > 0$ such that for all $x, y \in \Delta^n$,

$$d(x, y) < \delta \implies d(g(x), g(y)) < \epsilon.$$

Let T be a triangulation of Δ_n such that for each simplex Q in T ,

$$\sup_{x, y \in Q} d(x, y) < \delta.$$

It follows immediately that for all $x, y \in Q$ for any simplex Q in T ,

$$d(g(x), g(y)) < \epsilon. \tag{2.2}$$

Now, let us label each vertex v of T with the vertex of Δ_n that $g(v)$ is closest to under the Euclidean metric in $\partial\Delta_n$. Since a vertex on face F is closer to some vertex on face F than any other vertex in Δ_n , this labelling L is Sperner. Then, by Theorem 4, there exists a fully labelled simplex $S = \text{conv}(v_1, \dots, v_{n+1})$ in T , where $L(v_i) = i$. So, by Equation 2.2,

$$d(g(v_1), g(v_i)) < \epsilon \text{ for all } i \in [n + 1].$$

Now, $f(v_1)$ belongs to some $(n - 1)$ -face F . Let k be the vertex of Δ^n opposite to face F and let G denote a face containing $g(v_k)$. If $F = G$, then $g(v_k)$ would be closer to some vertex of F than it is to k , contradiction the fact that $L(v_k) = k$. Thus, $G \neq F$. By construction of ϵ , this must mean that $g(v_k)$ lies below the center of G , where k is on top. So, $g(v_k)$ must be closer to another vertex of G than it is to k . We visualize a 2-dimensional projection of this phenomenon in Figure 2.8.

This picture illustrates why $g(v_k)$ must be closer to another vertex of G than it is to k , which we stated above. But this contradicts the fact that v_k was labelled k . From this contradiction, we conclude that no retract $f : \mathcal{B}^n \rightarrow \mathcal{S}^{n-1}$ exists.

□

Finally, we prove the Brouwer Fixed Point Theorem. Recall the Brouwer Fixed Point Theorem states that every continuous map $f : \mathcal{B}^n \rightarrow \mathcal{B}^n$ has a fixed point.

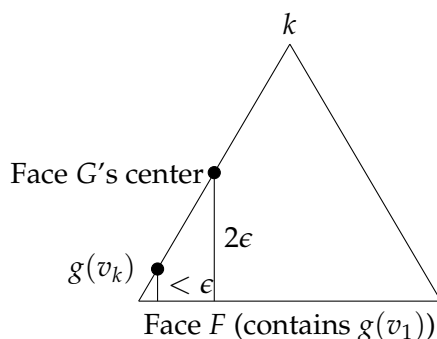

Figure 2.8 2-dimensional projection of where $g(v_k), g(v_1)$ appear on Δ^n

Proof of Brouwer Fixed Point Theorem. Suppose to the contrary that there exists a continuous map $f : B^n \rightarrow B^n$ without a fixed point. Then, define the map $g : B^n \rightarrow S^{n-1}$ by $g(x)$ being the intersection of the ray from $f(x)$ to x with the boundary S^{n-1} . We illustrate this map below:

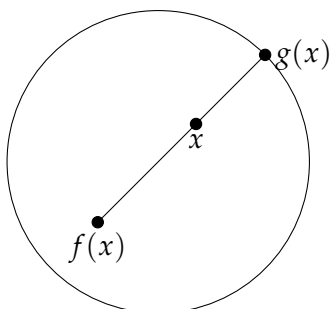

Figure 2.9 Creating a retraction g from f , which has no fixed points

As f is continuous, and $f(x) \neq x$ for all $x \in B^n$, g is continuous. Furthermore, for any $x \in S^{n-1}$, $g(x) = x$. Thus, $g : B^n \rightarrow S^{n-1}$ is a retract, contradicting the Theorem 5. Hence, every continuous map $f : B^n \rightarrow B^n$ has a fixed point.

□

Thus, we have proven Sperner's Lemma, a discrete result, and used it to establish the Brouwer Fixed Point Theorem. Our discrete approach is complete. This gives us some idea of how discrete proofs of topological

16 Sperner's Lemma and Brouwer Fixed Point Theorem

results work. The labelling and path ideas in Sperner's Lemma will be similar to ideas we explore later in the paper. Understanding the proof of Sperner's Lemma will help the reader understand the rest of the paper.

Chapter 3

The Steinhaus Chessboard Theorem

3.1 Background and Setup

In this chapter, we present Tkacz's and Turzański's proof of the Poincaré-Miranda Theorem, which is also a discrete proof (Tkacz and Turzański (2008)). The intermediary discrete analog is an n -dimensional generalization of the Steinhaus Chessboard Theorem. In this chapter, we first describe the Steinhaus Chessboard Theorem and its generalization by Tkacz and Turzański. Then, we present their proof of this generalization, which is done by finding a chain of simplices with certain properties first and then using that to establish the generalized Steinhaus Chessboard Theorem. Finally, we see how the generalized Steinhaus Chessboard Theorem can be used to prove the Poincaré-Miranda Theorem.

We first state the original Steinhaus Chessboard Theorem:

Theorem 6. *Consider an n by n chessboard. Place mines on any set of squares. Then, one of the following holds:*

1. *A king can move from the left to the right of the board without passing through any mined squares*
2. *A rook can move from the bottom to the top of the board using only mined squares.*

First, we say that the sets A_1, \dots, A_m form a (connected) *chain* if

$$A_i \cap A_{i+1} \neq \emptyset \text{ for all } i \in [m-1].$$

This is very intuitive definition of a chain. We just have that consecutive sets must have nonempty intersection. An implication of this theorem is that there is either a connected chain of non-mined squares from the left to the right, or a chain of mined squares from the top to the bottom. (The chain from the top to the bottom need not use diagonals, but that is irrelevant for our purposes.) Tkacz and Turzański generalize this theorem to n -dimensions as below. We present an informal version now and make it more formal later.

Theorem 7 (Generalized Steinhaus Chessboard Theorem - Informal). *Create a grid of n -dimensional cubes. Color each cube with one of n colors from $1, 2, \dots, n$. Then there exists a set of cubes all colored i which connect the corresponding opposite sides of the grid.*

For example, consider the 2-dimensional 4 by 4 grids colored white and black in Figure 3.1:

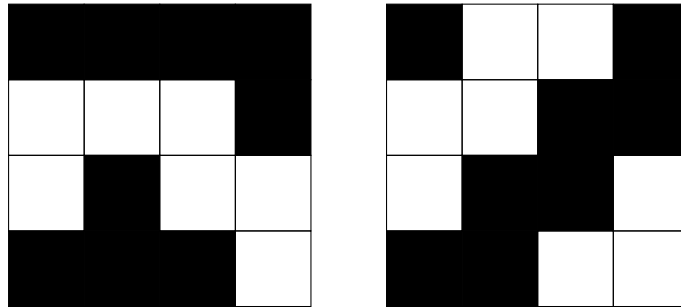

Figure 3.1 Example of the Steinhaus Chessboard Theorem in dimension 2

The Steinhaus Chessboard Theorem tells us that there either be a white chain from left to right, or a black chain from top to bottom. In the left grid, we have a white chain from the left to the right side, but no black chain from top to bottom, and vice versa for the right grid. Yet, in the left grid, note that we also have a black chain from left to right. This occurs because we can exchange which colors are associated to which sides in the Steinhaus Chessboard Theorem: we must either have a black chain from left to right or a white chain from top to bottom. As we don't have a white

chain from top to bottom, we must have a black chain from left to right. In fact, we can associate the colors with the sides in any 1-1 fashion. So, in fact, for any permutation σ of $[n]$, there exists an i -colored connected chain between the $\sigma(i)$ -th opposite sides of I^n for some i .

From now on, the Steinhaus Chessboard Theorem refers to this generalized result, not the 2-dimensional original.

Why does this make sense as a discrete analog for the Poincaré-Miranda Theorem? Well, consider $f = (f_1, \dots, f_n)$. One observes that the zero sets

$$Z(f_i) = \{x \in I^n \mid f_i(x) = 0\}$$

are hypersurfaces that must block all paths from I_i^- , where $f_i < 0$ to I_i^+ , where $f_i > 0$, because we can't get from negative to positive continuously without passing through 0. Hence, we expect that $Z(f_i)$ to be a hypersurface connecting all but the i -th opposite faces. Then, one would also expect that these n zero sets, which we expect to be $(n - 1)$ -dimensional, intersect at at least a point. For example, in 2 dimensions, we expect these zero sets to be curves between the first and second pairs of opposite faces, like in Figure 3.2:

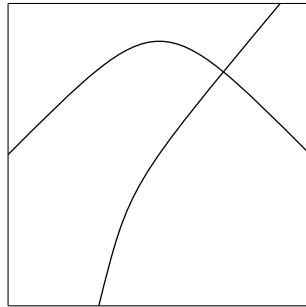

Figure 3.2 Any two curves between the pairs of opposite sides of a square must intersect.

where the curves represent zero sets. In 2 dimensions, it is very intuitive that 2 curves connecting opposite sides must intersect. Geometric intuition also suggests that this should generalize to n dimensions - the n zero set hypersurfaces have at least one common point of intersection. This intersection is of course the set of zeros of f , and showing this is nonempty will prove the Poincaré-Miranda Theorem.

Conversely, is there some way that $f \neq 0$ anywhere within I^n make sense?

Now, if we color the our cubes such that $f_i \neq 0$ on all i colored cubes, then an i -colored connected chain between the i -th opposite side would represent the fact that the zero set $Z(f_i)$ does not block all chains between the i -th opposite sides. How would this help us? The existence of colored chain between the i -th opposite sides, on which $f_i \neq 0$, makes no sense. So, no such chain can exist, and then we see that each zero set $Z(f_i)$ does block all chains between the i -th opposite sides. Then, using this property, we see intuitively that this means the n zero sets must interesect in at least a point.

We will see how this idea plays out in the proof. Of course, this is not a rigorous argument, but we can make it rigorous by discretizing the problem first, and then bringing it back to a topological problem. Discrete approaches have the potential to turn ideas like this into rigorous proofs.

We will present a more formal statement of the generalized Steinhaus Chessboard Theorem later as we go through their argument, which we refer to as the connected chain argument since they argue for the existence of a connected chain. First, we prove the existence of such a chain. Then, we prove the Poincaré-Miranda Theorem using the generalized Steinhaus Chessboard Theorem.

We now present my clarified interpretation of Tkacz's and Turzański's proof. First, we will discuss relevant notation and preliminaries. Consider a decomposition of I^n with cubes of size $\frac{1}{k}$:

$$T(k) = \left\{ \left[\frac{i_1}{k}, \frac{i_1+1}{k} \right] \times \dots \times \left[\frac{i_n}{k}, \frac{i_n+1}{k} \right] \mid i_j \in \{0, 1, \dots, k-1\} \right\}.$$

Here, $T(k)$ is just an n -dimensional grid of cubes. In figure 3.3, we show $T(4)$ in dimension 2:

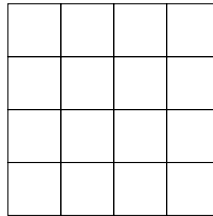

Figure 3.3 $T(4)$ is a 4 by 4 grid of squares.

Next, define

$$C(k) = \left\{ -\frac{1}{2k}, \frac{1}{2k}, \dots, 1 - \frac{1}{2k}, 1 + \frac{1}{2k} \right\}^n.$$

which is the set of the centers of all the cubes in $T(k)$ plus one layer of points surrounding the entire cube. Adding the vertices of $C(4)$ to $T(4)$, we get Figure 3.4:

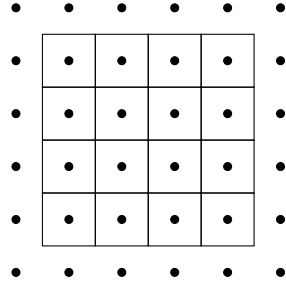

Figure 3.4 $C(k)$ is the set of centers of the cubes in $T(k)$, plus one exterior layer.

Note that for each cube $t \in T(k)$, there is a unique $z \in C$ such that $z \in t$. Furthermore, we have the points in C on the sides given by

$$C(k)_i^- = \left\{ x \in C(k) \mid x(i) = -\frac{1}{2k} \right\}, \quad C(k)_i^+ = \left\{ x \in C(k) \mid x(i) = 1 + \frac{1}{2k} \right\}$$

and set of exterior points in $C(k)$ given by

$$\partial C(k) = \bigcup_{i=1}^n (C(k)_i^- \cup C(k)_i^+).$$

Let

$$e_i = (0, \dots, 0, \frac{1}{k}, 0, \dots, 0).$$

with $e_i(i) = \frac{1}{k}$ be the i -th basis vector for $i \in [n]$. Now, we can triangulate the cube $[0, \frac{1}{k}]^n$ using the simplices

$$(Tr)_{n,k} = \left\{ \left[0, e_{\alpha(1)}, \dots, \sum_{i=1}^r e_{\alpha(i)}, \dots, \left(\frac{1}{k}, \dots, \frac{1}{k} \right) \right] \mid \alpha \in S_n \right\}. \quad (3.1)$$

where S_n is the set of all permutations of $[n] = \{1, \dots, n\}$. We visualize this in two dimensions in Figure 3.5:

Next, let

$$T'(k) = \left\{ \left[\frac{2i_1 - 1}{2k}, \frac{2i_1 + 1}{2k} \right] \times \dots \times \left[\frac{2i_n - 1}{2k}, \frac{2i_n + 1}{2k} \right] \mid i_j \in \{0, 1, \dots, k\} \right\}.$$



Figure 3.5 The triangulation $(Tr)_{2,k}$ of $\left[0, \frac{1}{k}\right]^2$.

represent the set of n -dimensional cubes with side length $\frac{1}{k}$ using vertices in $C(k)$. This is basically a shifted version of T with another layer of cubes on the outside. Note that the vertices of $T'(k)$ lie in $C(k)$. We add in $T'(4)$ to $T(4)$ and $C(4)$ in Figure 3.6:

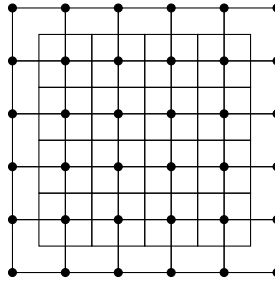

Figure 3.6 $T'(k)$ is the set of cubes of side length $\frac{1}{k}$ using the vertices in $C(k)$.

Let \mathcal{S} be the triangulation of $\left[-\frac{1}{2k}, 1 + \frac{1}{2k}\right]^n$ into simplices where each $t \in T'(k)$ is triangulated using a shifted triangulation $(Tr)_{n,k}$ of $\left[0, \frac{1}{k}\right]^n$ in Equation 3.1. By the symmetry of $(Tr)_{n,k}$ in Equation 3.1, \mathcal{S} is a triangulation of $\left[-\frac{1}{2k}, 1 + \frac{1}{2k}\right]^n$. Finally, for any simplex S , let $V(S)$ refer to the vertices of S .

3.2 Proving the Steinhaus Chessboard Theorem

Next, we extend an arbitrary coloring of $T(k)$ to a labelling on $C(k)$, and then prove that we have a chain of simplices in \mathcal{S} with certain properties, to be explained below.

Lemma 8. For a coloring function $F : T(k) \rightarrow [n]$, define a labelling $\phi : C(k) \rightarrow [n]$ by

$$\phi(z) = F(t) \text{ for } z \in t \in T(k)$$

for $z \notin \partial C(k)$. And, let

$$\phi(z) = \min\{i \mid z \in C(k)_i^- \cup C(k)_{(i+1) \bmod n}^+\} \quad (3.2)$$

for $z \in \partial C$. Then, there exists a chain of simplices $S_1, \dots, S_m \in \mathcal{T}$ such that

$$\phi(V(S_p \cap S_{p+1})) = [n]$$

for all $p \in [m-1]$. Also, for the end simplices S_1 and S_m , we have

$$S_1 \cap C(k)_i^- \neq \emptyset, \quad S_m \cap C(k)_i^+ \neq \emptyset.$$

for all $i \in [n]$.

Proof. In this proof, one should notice many similarities to the proof of Sperner's Lemma. First, note that ϕ is well defined because, for all $t \in T(k)$, there exists a unique $z \in C$ such that $z \in t$.

We say a simplex S is n -colored if $\phi(V(S)) = [n]$. First, let $S_1 = \text{conv}(z_0, z_1, \dots, z_n)$ where

$$z_i(j) = \begin{cases} -\frac{1}{2k} & \text{if } j > i \\ \frac{1}{2k} & \text{if } j \leq i \end{cases}.$$

This face lies by the $(-\frac{1}{2k}, -\frac{1}{2k}, \dots, -\frac{1}{2k})$ corner of $T'(k)$. Then, by Equation 3.2, $\phi(z_i) = i + 1$ for all $0 \leq i \leq n - 1$, so S_1 is n -colored. Now, let us construct a chain of simplices inductively. Suppose that S_j has a single unused (that is, not shared by another simplex in the chain $\{S_i\}$) n -colored face that does not intersect $\partial C(k)$. Now, any n -colored simplex, which has $n + 1$ vertices, has exactly 2 n -colored faces. As S_1 has one n -colored face $\text{conv}(z_0 \dots z_{n-1})$ on the boundary, it has exactly one n -colored face, say F , not used by another simplex or on the boundary.

Let us begin an algorithm staring at this S_1 . Let F be the single unused n -colored face of S_j . Note that F is shared by another unique simplex in \mathcal{T} if and only if F does not intersect $\partial C(k)$. Then, let $S_{j+1} \in \mathcal{T}$ be the unique simplex sharing face F with S_j . Now both of S_j 's n -colored faces are used, and one of S_{j+1} n -colored faces is left unused. So, we add S_{j+1} to the chain and repeat inductively unless F 's vertices are all in $\partial C(k)$. This process must terminate because \mathcal{T} has a finite number of simplices. Thus, we have a chain of simplices S_1, \dots, S_m that proceeds from S_1 to intersect $\partial C(k)$ such that

$$\phi(V(S_p \cap S_{p+1})) = [n].$$

However, an $(n - 1)$ -face intersecting $\partial C(k)$ that is n -colored must have a vertex belonging to $C_i^- \cup C_{(i+1) \bmod n}^+$ for all $i \in [n]$ by Equation 3.2. So, it must be either $\text{conv}(z_0, \dots, z_{n-1})$ or $\text{conv}(w_0, \dots, w_{n-1})$ where

$$w_i(j) = \begin{cases} 1 + \frac{1}{2k} & \text{if } j > i \\ 1 - \frac{1}{2k} & \text{if } j \leq i \end{cases}$$

for $0 \leq i \leq n$. This simplex is simply a reflection of $\text{conv}(z_0, \dots, z_{n-1})$ lies by the $(1 + \frac{1}{2k}, 1 + \frac{1}{2k}, \dots, 1 + \frac{1}{2k})$ corner of $T'(k)$. We see that $\phi(w_i) = i$ for all i by definition, so $\phi(\text{conv}(w_0, \dots, w_{n-1})) = [n]$. So, the last simplex in our chain, S_m must be $\text{conv}(w_0, \dots, w_n)$, which is the n -simplex in our triangulation \mathcal{T} with $\text{conv}(w_0, \dots, w_{n-1})$ as a face. Furthermore, S_1 and S_m defined above satisfy

$$S_1 \cap C_i^- \neq \emptyset, \quad S_m \cap (C_i^+) \neq \emptyset.$$

for all $i \in [n]$. Thus, we have our chain of simplices $S_1 \dots S_m$ with the desired properties. □

This proof is remarkably similar to Sperner's Lemma: mainly, we construct the paths in basically the same way. We give a 2-dimensional example of this theorem in action in Figure 3.7.

The next idea is to use this chain of simplices to construct a chain of cubes in $T(k)$ with similar properties, and this will give us the Steinhaus Chessboard Theorem we have alluded to earlier. Once we have the lemma above, constructing this chain is relatively straightforward. We next state and prove a formal version of the Steinhaus Chessboard Theorem using Lemma 8.

Theorem 9 (Generalized Steinhaus Chessboard Theorem - Formal). *For any coloring function $F : T(k) \rightarrow [n]$, there exists cubes P_1, \dots, P_r , all colored i , in $T(k)$ such that*

$$P_j \cap P_{j+1} \neq \emptyset, \quad P_1 \cap I_i^- \neq \emptyset, \quad P_r \cap I_i^+ \neq \emptyset$$

for some $i \in [n]$.

Proof. Define $\phi : C(k) \rightarrow [n]$ as in Lemma 8. By Lemma 8, there exists a chain of simplices S_1, \dots, S_m in \mathcal{T} satisfying the properties of Lemma 8. As $S_m \cap C_i^+ \neq \emptyset$ for all i , there exists a smallest index ℓ_1 such that

$$S_{\ell_1} \cap C(k)_i^+ \neq \emptyset$$

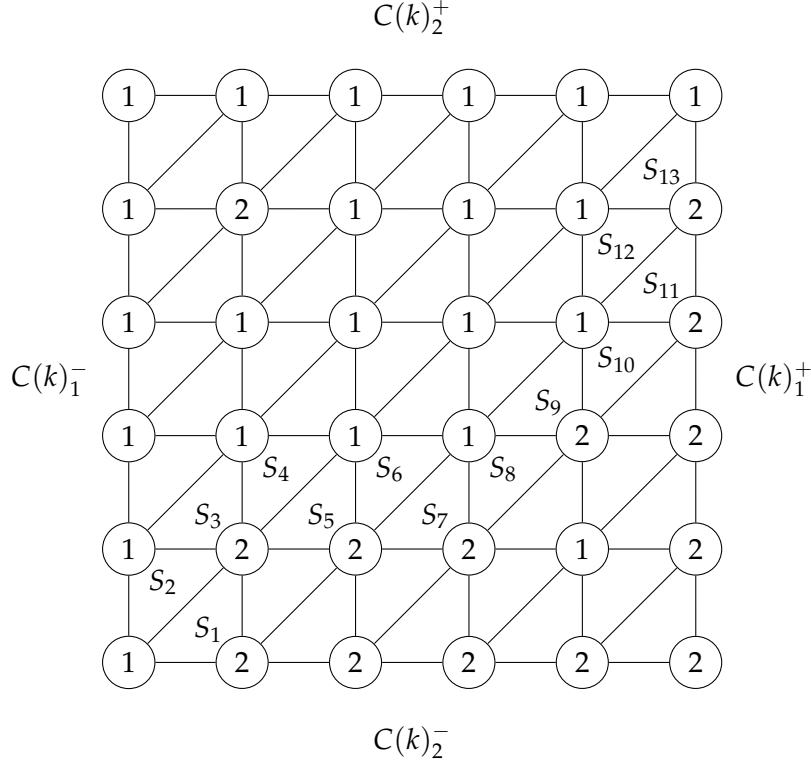

Figure 3.7 We get a chain of simplices between opposite corners in I^n , where $V(S_p \cap S_{p+1})$ is n -colored for all p .

for some $i \in [n]$. Then, for this i , let ℓ_2 be the largest index such that

$$S_{\ell_2} \cap C(k)_i^- \neq \emptyset$$

which exists because $S_1 \cap C(k)_i^- \neq \emptyset$. Here, we assume that $\ell_2 \leq \ell_1$. A similar approach will work if $\ell_1 \leq \ell_2$. For $\ell_2 \leq \ell_1$, the chain S_1, \dots, S_m does not hit $C(k)_i^+$ or $C(k)_i^-$ strictly between ℓ_2 and ℓ_1 .

As $\phi(S_j \cap S_{j+1}) = [n]$, we can find a sequence $\{z_j\}_{j=0}^{\ell_1 - \ell_2 - 1}$ with $z_j \in S_{\ell_2 + j} \cap S_{\ell_2 + j + 1}$ such that $\phi(z_j) = i$ for all j .

Let us show that for all $j \in [\ell_1 - \ell_2 - 1]$, z_j does not belong to $\partial C(k)$. By definition, the only points in ∂C that are colored i must belong to $C(k)_i^- \cup$

$C(k)_{(i+1) \bmod n}^+$. But by construction, $z_j \notin C_i^-$ for $j \geq 1$. Otherwise, we would contradict the definition of z_0 and ℓ_2 . Furthermore, we must have $z_j \notin C_{(i+1) \bmod n}^+$ for $j \leq \ell_1 - \ell_2 - 1$. Otherwise, we would contradict our definition of i , which was chosen to be the index such that the chain of simplices S_1, \dots, S_m touched C_i^+ before C_k^+ for any $k \neq i$. Therefore, for $1 \leq j \leq \ell_1 - \ell_2 - 1$, z_j does not belong to $C(k)_i^- \cup C(k)_{(i+1) \bmod n}^+$. Because the z_j are all colored i , we conclude that $z_j \notin \partial C(k)$ for all $j \in [\ell_1 - \ell_2 - 1]$.

Hence, there exists a cube $P_j \in T(k)$ containing z_j for all $j \in [\ell_1 - \ell_2 - 1]$. As each cube is centered at z_j , we have $F(P_j) = \phi(z_j) = i$ for all j . Now, $S_{\ell_2} \cap C(k)_i^-$ is a single point z_0 on the exterior $\partial C(k)$. So, the face opposite to this point in S_{ℓ_2} , say F , must be the one we went through in our chain, or $S_1 \cap S_2$, and is n -colored. Here, $z_1 \in S_1 \cap S_2$ is colored i . Then, z_1 belongs to the same simplex as z_0 , so z_1 is within $\frac{1}{2k}$ of I_i^- . Thus, we must have $P_1 \cap I_i^- \neq \emptyset$. Similarly, $P_{\ell_1 - \ell_2 - 1} \cap I_i^+ \neq \emptyset$. Furthermore, we know that $z_j, z_{j+1} \in S_{j+1} \in \mathcal{T}$. But by construction of \mathcal{T} , this means that

$$|z_j(s) - z_{j+1}(s)| \leq \frac{1}{k}$$

for all s , or that z_j and z_{j+1} differ by no more than $\frac{1}{k}$ in every coordinate. Now, each z_j is the center of P_j , so that any point away from z_j by no more than $\frac{1}{2k}$ in each coordinate is in P_j . So, as $\frac{1}{2}(z_j + z_{j+1})$ is away from z_j by no more than $\frac{1}{2k}$ in each coordinate,

$$\frac{1}{2}(z_j + z_{j+1}) \in P_j.$$

Similarly,

$$\frac{1}{2}(z_j + z_{j+1}) \in P_{j+1}.$$

Hence,

$$P_j \cap P_{j+1} \neq \emptyset \text{ for all } j \in [\ell_1 - \ell_2 - 1].$$

As $C(k)_i^- \subset I_i^-$, $C(k)_i^+ \subset I_i^+$, we have that

$$P_1 \cap I_i^- \neq \emptyset, \quad P_{\ell_1 - \ell_2 - 1} \cap I_i^+ \neq \emptyset.$$

Thus, after ignoring repeats of the same cube, we have a chain P_1, \dots, P_r with the desired properties.

□

We will show how the construction of the cubes plays out in Figure 3.8. In the example for Lemma 8, S_{10} was the first simplex to touch the right side C_1^+ . And, S_3 was the last simplex to touch the left hand side C_1^- . Using this, we construct the sequence $\{z_j\}$ described in Theorem 9. For convenience, we ignore repeats of the same vertex for the sequence $\{z_j\}$.

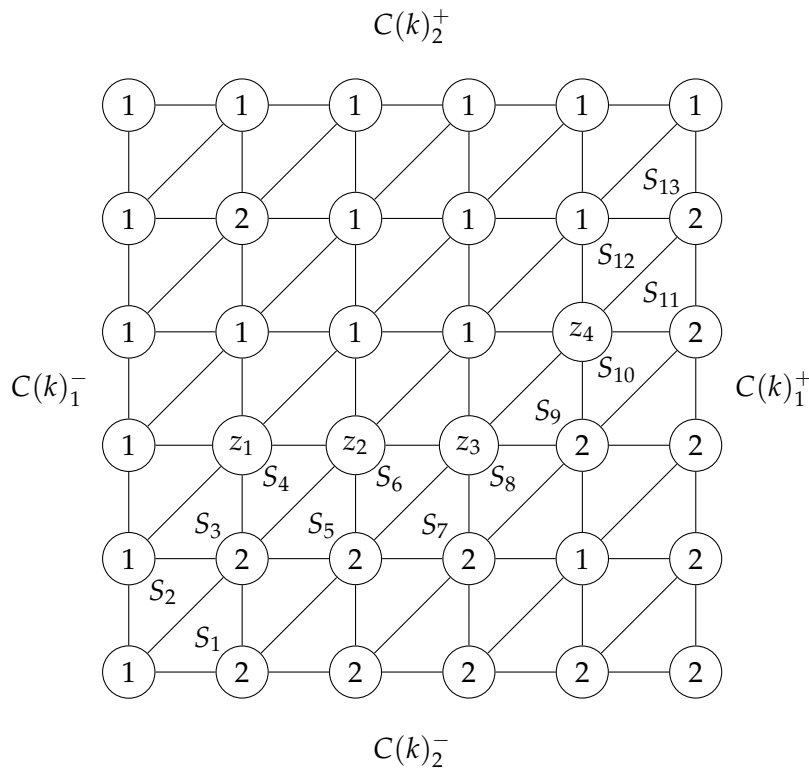

Figure 3.8 The chain of simplices in Lemma 8 gives rise to a sequence of i -colored points that are no more than $\frac{1}{k}$ apart in each coordinate going between I_i^- and I_i^+ .

Each vertex z_j in the sequence in Figure 3.8 is labelled 1. From the above sequence, we get the desired chain P_1, P_2, P_3, P_4 , which are colored 1, shown in Figure 3.9.

Now we have established our discrete analog. Finally, we use it to prove the Poincaré-Miranda Theorem.

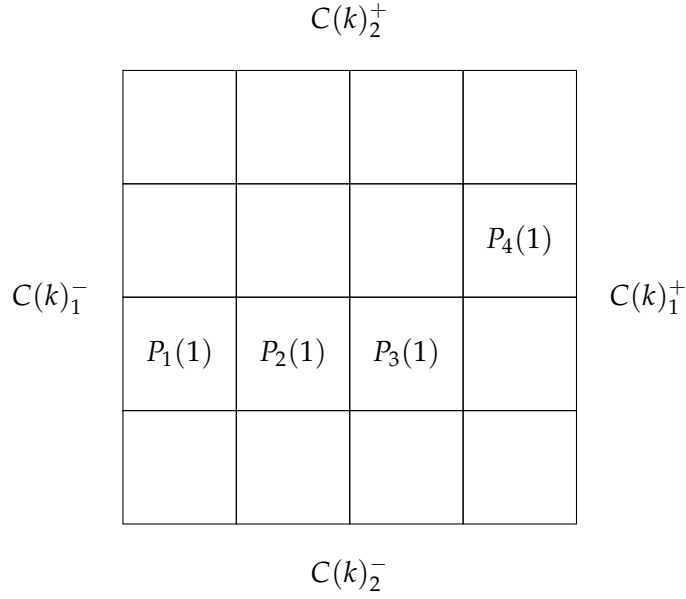

Figure 3.9 The sequence of points corresponds a sequence of cubes connecting I_i^- and I_i^+ .

3.3 Proving the Poincaré-Miranda Theorem with the Steinhaus Chessboard Theorem

Proof of Poincaré-Miranda Theorem. Suppose $f = (f_1, \dots, f_n) : I^n \rightarrow \mathbb{R}^n$ is continuous and

$$f_i(I_i^-) \subset (-\infty, 0), \quad f_i(I_i^+) \subset (0, \infty).$$

Suppose to the contrary that f does not have a zero in I^n . Then, let

$$U_i = \{x \in I^n \mid f_i(x) \neq 0\}.$$

Note that each U_i is open because $\mathbb{R} - \{0\}$ is open and each f_i is continuous. As $f \neq 0$ anywhere, $\{U_i\}_{i=1}^n$ is an open cover for I^n , which is compact. So, by the Riemann Lebesgue Lemma, there exists $\epsilon > 0$ such that for each $p \in I_n$,

$$B(p, \epsilon) \subset U_j$$

for some $j \in [n]$. So, choosing k such that $\frac{1}{k} < 2\sqrt{n}\epsilon$, so that each cube of side length $\frac{1}{k}$ is contained in a ball of radius ϵ , we have

$$t \in T(k) \implies t \in U_j \text{ for some } j \in [n].$$

So, each cube in $T(k)$ is contained within one of these open sets. Hence, the coloring function $F : T(k) \rightarrow [n]$ given by

$$F(t) = \min\{j \mid t \in U_j\}$$

is well-defined. So, by the Steinhaus Chessboard Theorem, there exists an i -colored chain P_1, \dots, P_r such that

$$P_j \cap P_{j+1} \neq \emptyset, \quad P_1 \cap I_i^- \neq \emptyset, \quad P_r \cap I_i^+ \neq \emptyset.$$

Thus there exists $x \in P_1 \cap I_i^-$, $y \in P_r \cap I_i^+$. Then, $f_i(x) < 0$, $f_i(y) > 0$. Furthermore, as we have a chain, $K := \bigcup_{j=1}^r P_j$ is connected, so $f(K)$ must be connected as f is continuous. Hence, $0 \in [f_i(x), f_i(y)] \subset f(K)$. So, there exists $p \in K$ such that

$$f_i(p) = 0.$$

However, $p \in P_j$ for some j , so as P_j is i -colored, $p \in U_i$. But this means that

$$f_i(p) \neq 0,$$

contradicting the above. We visualize this chain in Figure 3.10:

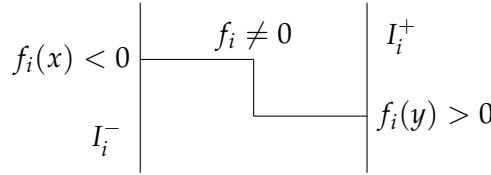

Figure 3.10 We have an i -colored chain, where $f_i \neq 0$, from I_i^- , where $f_i < 0$, to I_i^+ , where $f_i > 0$.

We conclude that f has a zero in I^n . This completes our proof of the Poincaré-Miranda Theorem via the Steinhaus Chessboard Theorem .

□

Chapter 4

Polytopal Sperner's Lemma

4.1 Polytopal Sperner's Lemma

In this chapter, we present an original proof of the Poincaré-Miranda Theorem using a generalization of Sperner's Lemma to polytopes. Although it is similar in spirit to the proof of the Poincaré-Miranda Theorem presented in Kulpa, it differs in the labelling it uses and the version of Sperner's Lemma used. In this proof, we have a simpler labelling and argument than that in Kulpa because we employ a stronger result. We present our original proof below.

Let $P \subset \mathbb{R}^n$ be a polytope, and let T be a triangulation of P into n -dimensional simplices. Let $\{v_1, \dots, v_m\}$ be the set of vertices of polytope P and let $V(T)$ be the set of vertices in triangulation T . Then, a labelling of T is a map $\ell : V(T) \rightarrow [m]$.

Definition 4 (Sperner Labelling). *Let P be a polytope with vertices $\{v_1, \dots, v_m\}$. Then, a labelling $\ell : V(T) \rightarrow [m]$ is Sperner if for all faces F of polytope P ,*

$$v \in F \text{ implies } \ell(v) \in \{i \mid v_i \in F\}.$$

This is a straightforward extension of a Sperner labelling from simplices to polytopes. In particular, this means that $\ell(v_i) = i$ for all vertices v_i of polytope P . So, a labelling of a triangulation is Sperner if every vertex within a face F is labelled the same as the index of some vertex of F . This must hold for all faces F of the polytope. In fact, using this generalized notion of a Sperner labelling, we get a generalized version of Sperner's Lemma.

Theorem 10 (Polytopal Sperner's Lemma). *Let $\ell : V(T) \rightarrow [m]$ be a Sperner Labelling of a triangulation T of polytope P . Then, there exists a simplex in T with distinct labels $j^{(0)}, j^{(1)}, \dots, j^{(n)}$ such that*

$$v_{j^{(0)}}, v_{j^{(1)}}, \dots, v_{j^{(n)}} \text{ do not all lie in the same proper face.} \quad (4.1)$$

By a proper face, we simply mean a face of dimension less than n . This result follows from a stronger result due to DeLoera-Peterson-Su (De Loera et al. (2002)), but it is all we need for our purposes here. Let us apply it in particular to I^n , and understand how 4.1 restricts the simplices $\text{conv}(v_{j^{(0)}}, v_{j^{(1)}}, \dots, v_{j^{(n)}})$ on vertices. Let us label the vertices of I^n in binary. In particular, let

$$(x_1, \dots, x_n) = v_{x_1, \dots, x_n}$$

when $x_i \in \{0, 1\}$ for all i . Furthermore, we construct our Sperner labelling in binary as well, so for vertices,

$$\ell(v_{x_1, \dots, x_n}) = (x_1, \dots, x_n).$$

We let j_i denote the i -th coordinate of binary label j . We call a simplex fully labelled as long as its vertices have distinct labels.

Theorem 11 (Polytopal Sperner's Lemma on a Cube). *Let $\ell : V(T) \rightarrow [m]$ be a Sperner Labelling of a triangulation T of I^n . Then, there exists a simplex in T whose vertices have distinct binary labels $j^{(0)}, j^{(1)}, \dots, j^{(n)}$ such that for all i , there exists $a_i, b_i \in \{0, \dots, n\}$ with*

$$j_i^{(a_i)} = 0, \quad j_i^{(b_i)} = 1. \quad (4.2)$$

Proof. By Polytopal Sperner's Lemma, there exists a simplex in T with distinct binary labels $j^{(0)}, j^{(1)}, \dots, j^{(n)}$ satisfying inequality 4.1. Now, suppose to the contrary there exists some i such that $j_i^{(k)}$ is constant for all $k \in [n]$. Then, by definition, we would have $v_{j^k} \in I_i^-$ or $v_{j^k} \in I_i^+$ for all $k \in [n]$. But, either way,

$$v_{j^{(0)}}, v_{j^{(1)}}, \dots, v_{j^{(n)}} \text{ all lie in } I_i^- \text{ or } I_i^+,$$

contradicting Condition 4.1. So we conclude that for all i , there exists $a_i, b_i \in \{0, \dots, n\}$ with

$$j_i^{(a_i)} = 0, \quad j_i^{(b_i)} = 1.$$

□

We refer to a simplex as fully labelled as long it has distinct labels. Condition 4.2 says that the binary labels of the fully labelled simplex must, as a whole, contain a 0 and a 1 in each coordinate. We give an example in 2 dimensions of a binary Sperner labelling on a square and we point out 2 fully labelled simplices whose corresponding vertices satisfy Condition 4.2 in Figure 4.1:

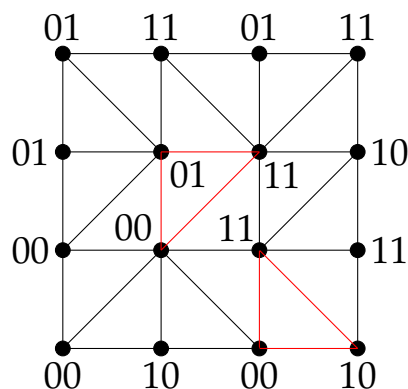

Figure 4.1 We have a Sperner labelling of a triangulation of I^2 , and we have two fully labelled simplices.

Then, the triangle labelled in red has distinct labels whose corresponding vertices are not all contained in a proper face. This triangle also has the labels 00, 01, 11, which, considering the labels as a whole have a 0 and 1 in each coordinate. So, they satisfy the condition in Polytopal Sperner's Lemma on a Cube.

Now, we are ready to prove the Poincaré-Miranda Theorem via Theorem 11.

4.2 Proving the Poincaré-Miranda Theorem with Polytopal Sperner's Lemma

Proof of Poincaré-Miranda Theorem. Consider any continuous function $f = (f_1, \dots, f_n) : I^n \rightarrow \mathbb{R}^n$ satisfying

$$f_i(I_i^-) \subset (-\infty, 0), \quad f_i(I_i^+) \subset (0, \infty)$$

for all $i \in [n]$. Let T be any triangulation of I^n . We then define a binary labelling $\ell : V(T) \rightarrow \{0, 1\}^n$ whose coordinates are given as follows:

$$\ell_i(v) = \begin{cases} 1 & \text{if } f_i(v) \geq 0 \\ 0 & \text{if } f_i(v) < 0 \end{cases} . \quad (4.3)$$

Lemma 12. *The labelling ℓ defined above is a Sperner labelling on I^n .*

Proof. Suppose that w is in some proper face F on I^n . (The Sperner condition is trivially true for the only non-proper face - the whole of I^n .) Then, we can find a nonempty set of coordinates $\{i_1, i_2 \dots i_k\} \subset [n]$ such that

$$F = \{x \in I^n \mid x_{i_r} = g(i_r) \text{ for all } r \in [k]\}$$

for some map $g : \{i_1, i_2 \dots i_k\} \rightarrow \{0, 1\}$. That is, face F is defined by each element of this set of coordinates as equal to either 0 or 1. Then, we can write F as an intersection of $(n - 1)$ -dimensional faces:

$$F = \left(\bigcap_{\{r \mid g(i_r)=0\}} I_{i_r}^- \right) \cap \left(\bigcap_{\{r \mid g(i_r)=1\}} I_{i_r}^+ \right) .$$

Hence, by condition 1.2, we know that for each coordinate i_r ,

$$f_{i_r}(w) < 0 \text{ if } g(i_r) = 0, \quad f_{i_r}(w) > 0 \text{ if } g(i_r) = 1.$$

So, by Definition 4.3,

$$\ell_{i_r}(w) = g(i_r)$$

for all $r \in [k]$. By the definition of face F , this means that the vertex $v_{\ell(w)}$ belongs to face F . Thus, w shares a label with some vertex of F , meaning that ℓ is Sperner. □

Using this fact, and the compactness of I^n , we can prove the existence of a zero. Consider $\epsilon > 0$, and let d be the Euclidean metric in \mathbb{R}^n . Since f is continuous on a compact set and hence uniformly continuous, there exist $\delta > 0$ such that

$$d(x, y) < \delta \text{ implies } d(f(x), f(y)) < \frac{\epsilon}{\sqrt{n}} .$$

Now, let R_k refer to a sequence of triangulations of I^n into simplices such that

$$\max_{x,y \in Q} d(x,y) < \frac{1}{k} \text{ for all } Q \in R_k.$$

There exists simplices $Q_k \in R_k$ such that Q_k has distinct binary labels satisfying the condition of Theorem 11.

Consider any sequence $\{p_k\}$ with $p_k \in Q_k$. Now, consider K_0 large enough such that $\frac{1}{K_0} \leq \delta$. Fix any $k \geq K_0$. Then, for all $x, y \in Q_k$,

$$d(x,y) < \frac{1}{k} < \frac{1}{K_0} < \delta \implies d(f(x), f(y)) < \frac{\epsilon}{\sqrt{n}}.$$

As Q_k satisfies the condition 4.2 in Theorem 11, for all i , there exists vertices x_i, y_i of Q_k such that

$$\ell_i(x_i) = 0, \quad \ell_i(y_i) = 1.$$

By Definition 4.3,

$$f_i(x_i) < 0, \quad f_i(y_i) \geq 0.$$

As $x_i, y_i \in Q_k$,

$$d(f(x_i), f(p_k)) < \frac{\epsilon}{\sqrt{n}}, \quad d(f(y_i), f(p_k)) < \frac{\epsilon}{\sqrt{n}}.$$

So, in particular, we must have

$$f_i(y_i) - \frac{\epsilon}{\sqrt{n}} < f_i(p_k) < f_i(x_i) + \frac{\epsilon}{\sqrt{n}}.$$

As $f_i(x_i) < 0, f_i(y_i) \geq 0$, the previous inequality implies

$$|f_i(p_k)| < \frac{\epsilon}{\sqrt{n}}.$$

So, we have

$$|f(p_k)| < \sqrt{\sum_{i=1}^n \left(\frac{\epsilon}{\sqrt{n}}\right)^2} = \epsilon.$$

But this tells us that in \mathbb{R}^n ,

$$f(p_k) \rightarrow 0.$$

Now, we know I^n is compact, so there exists a convergent subsequence $\{p_{k_r}\}$ of $\{p_k\}$ such that $p_{k_r} \rightarrow p$ for some $p \in I^n$ - see Figure 4.2 for a

visualization of this. Then, $\{f(p_{k_r})\}$ is also a subsequence of $\{f(p_k)\}$, so $f(p_{k_r}) \rightarrow 0$ as well. By the continuity of f , we conclude that

$$f(p) = \lim_{r \rightarrow \infty} f(p_{k_r}) = 0.$$

So, f has a zero in I^n .

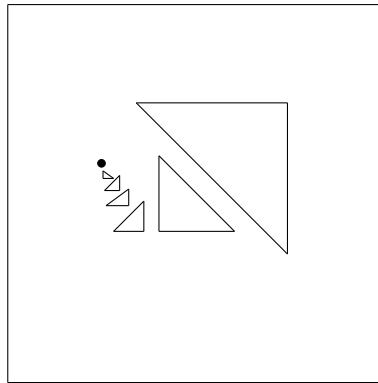

Figure 4.2 We can find a convergent subsequence of points within the simplices from Polytopal Sperner's Lemma. The limit point of this convergent subsequence is a zero of f .

□

Chapter 5

Another Zero Theorem

5.1 Morales's Generalization of the Intermediate Value Theorem

There is another way we can generalize the Intermediate Value Theorem. In this section, we let $I = [-1, 1]$, not $[0, 1]$, which we used in all previous sections. We can restate the Intermediate Value Theorem as follows: if $f : I \rightarrow \mathbb{R}$ is continuous and

$$\langle f(x), x \rangle > 0 \text{ for } x = \pm 1,$$

then there exists $x \in I^n$ such that $f(x) = 0$ (Morales (2002)). Here, $\langle \cdot, \cdot \rangle$ is the Euclidean inner product on \mathbb{R}^n given by

$$\langle x, y \rangle = \sum_{i=1}^n x_i y_i.$$

We can generalize the above by simply keeping the boundary condition as the above inner product, and this turns out to hold for I^n as well (Morales (2002)). Let

$$\partial I^n = \bigcup_{i=1}^n (I_i^+ \cup I_i^-)$$

denote the boundary of the cube I^n .

Theorem 13 (Morales). *If $f : I^n \rightarrow \mathbb{R}^n$ is continuous and satisfies*

$$\langle f(x), x \rangle > 0 \text{ for all } x \in \partial I^n,$$

then there exists $x \in I^n$ such that $f(x) = 0$.

5.2 Discrete Proof in Dimension 2

We are interested in proving this geometric result using combinatorial methods. In this case, we have found an original discrete proof of this result in dimension 2. The proof again finds a fully labelled simplex of a particular labelling. We shall prove the following:

Theorem 14. *Suppose that $f : I^2 \rightarrow \mathbb{R}^2$ is continuous and satisfies*

$$\langle f(x), x \rangle > 0 \text{ for all } x \in \partial I^2. \quad (5.1)$$

Then there exists $x \in I^n$ such that $f(x) = 0$.

Proof. First, let $f = (f_1, f_2)$. Let T be a triangulation of I^2 . Let us label the vertices of the triangulation T as follows:

$$\ell(v) = \begin{cases} 1 & \text{if } f_1(v) \geq 0, f_2(v) \geq 0 \\ 2 & \text{if } f_1(v) < 0, f_2(v) \geq 0 \\ 3 & \text{if } f_1(v) < 0, f_2(v) < 0 \\ 4 & \text{if } f_1(v) \geq 0, f_2(v) < 0 \end{cases}.$$

This creates a labelling $\ell : V(T) \rightarrow \{1, 2, 3, 4\}$. This is actually the same labelling we used for the square in our proof of the Poincaré-Miranda Theorem using Polytopal Sperner Lemma's except that we use the labels $\{1, 2, 3, 4\}$ instead of the binary labels $\{00, 01, 10, 11\}$. Equivalently, v is labelled by the quadrant $f(v)$ lies in, with the quadrants given by

$$\begin{aligned} Q_1 &= \{(x, y) \in \mathbb{R}^2 \mid x \geq 0, y \geq 0\}, & Q_2 &= \{(x, y) \in \mathbb{R}^2 \mid x \leq 0, y \geq 0\} \\ Q_3 &= \{(x, y) \in \mathbb{R}^2 \mid x \leq 0, y \leq 0\}, & Q_4 &= \{(x, y) \in \mathbb{R}^2 \mid x \geq 0, y \leq 0\}, \end{aligned}$$

with some negligible choices made at the axes. However, because of the different boundary condition, ℓ need not be Sperner.

Now, since ∂I^2 is compact, the image $f(\partial I^2)$ is compact as well, and it can't include 0 by Equation 5.1. This means that there exists a ball $B(0, \epsilon)$ in \mathbb{R}^2 for some $\epsilon > 0$ such that $B(0, \epsilon) \cap f(\partial I^2) = \emptyset$. Next, by continuity, there exists $\delta > 0$ such that

$$d(x, y) < \delta \implies d(f(x), f(y)) < \epsilon. \quad (5.2)$$

We call a triangulation "fine-enough" if for any simplex S in T ,

$$\sup_{x, y \in S} d(x, y) < \delta. \quad (5.3)$$

Lemma 15. Let \mathcal{T} be the set of all fine-enough triangulations that includes the points $(\pm 1, 0), (0, \pm 1)$ and at least 1 other vertex in each quadrant as vertices. Then, for each $T \in \mathcal{T}$,

1. No 13 or 24 edges appear in T .
2. If $v \in Q_i$ for $i \in \{1, 2, 3, 4\}$, then $\ell(v) \neq$ the number of the quadrant opposite Q_i . Or,

$$\begin{aligned} v \in Q_1 &\implies \ell(v) \neq 3, & v \in Q_2 &\implies \ell(v) \neq 4 \\ v \in Q_3 &\implies \ell(v) \neq 1, & v \in Q_4 &\implies \ell(v) \neq 2. \end{aligned}$$

3. There exists a vertex $v \in Q_i$ labelled i for all $i \in \{1, 2, 3, 4\}$.

Proof. Let $T \in \mathcal{T}$. Let $x, y \in V(T) \cap \partial I^2$ be adjacent vertices on the boundary. So, $f(x), f(y) \in f(\partial I^2)$, the image of the boundary. Then, by conditions 5.2 and 5.3,

$$d(f(x), f(y)) < \epsilon.$$

Now, because $B(0, \epsilon) \cap f(\partial I^2) = \emptyset$, it is impossible for $f(x)$ and $f(y)$ to be in opposite quadrants, namely Q_1 and Q_3 or Q_2 and Q_4 . We illustrate this in Figure 5.1:

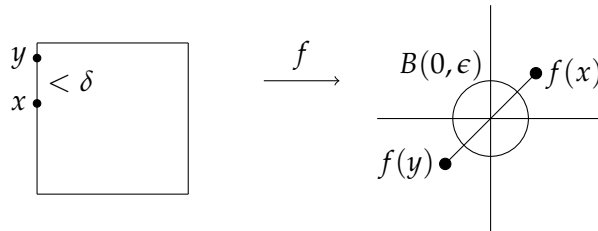

Figure 5.1 In fine enough triangulations, two adjacent vertices on ∂I^2 cannot be mapped to opposite quadrants by f .

If $f(x)$ and $f(y)$ were in opposite quadrants, they would be at least ϵ apart, because they lie outside $B(0, \epsilon)$, but we know this cannot happen. Thus, fine-enough triangulations avoid all instances of 13 or 24 edges on the boundary ∂I^2 . This proves condition 1 in Lemma 15.

Furthermore, we can also interpret the boundary condition as stating that $f(x)$ and x can't be apart by an angle of $\frac{\pi}{2}$ or more. So, f can't move points from one quadrant to its opposite quadrant. Thus, we can't have

labels of any quadrant in its opposite quadrant. This proves condition 2 in Lemma 15.

Furthermore, as f can't move points by an angle of $\frac{\pi}{2}$ or more,

$$\ell(1,0) \in \{1,4\}, \ell(0,1) \in \{1,2\}, \ell(-1,0) \in \{2,3\}, \ell(0,-1) \in \{3,4\}.$$

Suppose to the contrary that there is no label of 1 in Q_1 . But then, Q_1 must look like Figure 5.2:

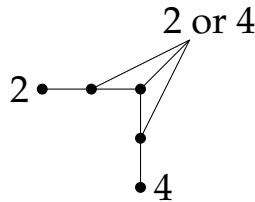

Figure 5.2 Without a 1 in Q_1 , we would have only 2s and 4s, forcing a 24 edge.

where we may have many vertices between this 2 and 4. And, without any 1s in Q_1 , we can only have 2s and 4s in Q_1 , and then there is no way to avoid a 24 edge, which we know we cannot have. Hence, there is at least one 1 in Q_1 . Similarly, there is at least one i in Q_i for all $i \in \{1,2,3,4\}$, proving condition 3 in Lemma 15.

□

Next, using these conditions, we show that there must be an odd number of 12 edges on ∂I^2 . Without loss of generality, suppose that label i in Q_i appears at the corner of the square in that quadrant, and that $\ell(0,1) = 1$. Then, we have at least the labels in Figure 5.3:

Consider the segment from $(-1,1)$, labelled 2, to $(0,1)$, labelled 1, in the picture above. I claim there must exist an odd number of 12 edges of T on this segment. We are in Q_2 , so no 4 appears. Also, as we move from left to right from the leftmost 2 to the rightmost 1 on this segment, there must exist an odd number of switches from 1 to 2 or 2 to 1. During such a switch, we can't have any intervening 4's because no 4's appear in Q_2 . Also, we can't have any intervening 3's because we cannot have any 13 edges in T . Hence, each 1 to 2 or 2 to 1 switch must take place along a 12 edge (in either order). Moreover, each 12 edge causes a switch from 1 to 2 or 2 to 1. It follows that there are an odd number of 12 edges in T along this segment. This segment must look like Figure 5.4:

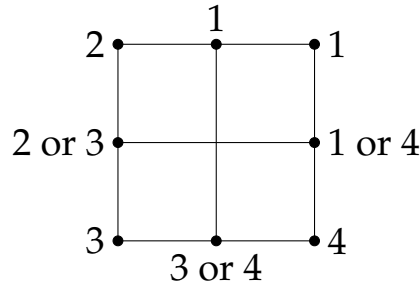

Figure 5.3 We know each corner must be labelled with its quadrant, and each midpoint must be labelled with one its two adjacent quadrants.

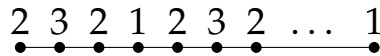

Figure 5.4 The $(0,1)$ to $(-1,1)$ edge must be of this form, where each number i actually represents a sequence of i 's in a row, and the 3 sequences are allowed to be empty, in which case the 2 sequence after it can be combined with the previous 2 sequence.

We see that each 1 to 2 or 2 to 1 switch must take place on a 12 edge. And we have an odd number of these because we start with 2 and end with 1.

In fact, similarly, each 1 to 2 or 2 to 1 switch in Q_1 or Q_2 has a one-to-one correspondence with 12 edges in T . Next, consider the vertical segment from $(-1, 1)$, labelled 2, to $(-1, 0)$, labelled 2 or 3 - above. Again, we are in Q_2 , so we can have only 1s, 2s, or 3s. Suppose to the contrary that the last 1 or 2 before we end at $(-1,1)$ is a 1. Then, this segment would have to end with a 13 edge in T which we know we can't have, followed by some number of 3s - see Figure 5.5:

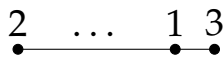

Figure 5.5 The $(-1,1)$ to $(-1,0)$ edge cannot end in a 13, where the last 3 represents a nonempty sequence of 3s.

Therefore, the last 1 or 2 must be a 2, so we have an even number of 1 to 2 or 2 to 1 switches. So, by the above, we have an even number of 12 edges in T on this segment. Furthermore, on the $(0,1)$, labelled 1, to $(1,1)$,

labelled 1, segment above, we must have an even number of 1 to 2 or 2 to 1 switches, and thus an even number of 12 edges. Also, similarly to the previous argument, we must have an even number of 12 edges on the (1,1), labelled 1, to (1,0), labelled 1 or 4 segment. Lastly, we can have no 12 edges in Q_3 or Q_4 because we cannot have any 1s in Q_3 or 2s in Q_4 . We have shown that the number of 12 edges in each section of ∂I^2 is as in Figure 5.6:

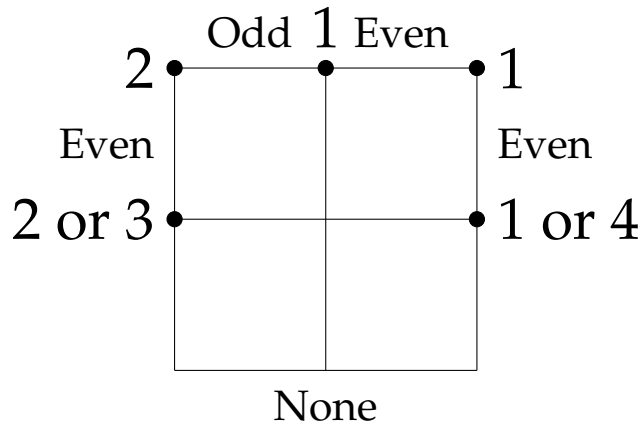

Figure 5.6 The parity of the number of 12 edges in each region of ∂I^2 .

This demonstrates that ∂I^2 contains an odd number of 12 edges in T .

Finally, we can use the same path chasing argument used to prove Sperner's Lemma on these 12 edges on ∂I^2 to find a simplex with 3 distinct labels in T . Constructing paths using the same technizue as in Sperner's Lemma, we again see that type 1 paths, which start and end on the boundary, use 2 doors, or 12 edges. As we have an odd number of 12 edges, there is at least one type 2 path, which must end in a fully labelled simplex in T .

As we are in 2 dimensions, the vertices corresponding to these distinct labels satisfy the nonzero volume condition 4.1 and condition 4.2 if treated as binary labels. Therefore, we can find a sequence of finer and finer triangulations $\{R_k\}$, all of which are "fine enough" to guarantee the labelling boundary conditions above hold, such that

$$\lim_{k \rightarrow \infty} \left(\sup_{x,y \in S \in R_k} d(x,y) \right) = 0,$$

where S ranges over all simplices in R_k . Then, by the same argument as

used in the Polytopal Sperner's Lemma section to deduce that we have a zero, we can deduce that f has a zero.

□

Chapter 6

Conclusion

In this thesis, we demonstrated the utility of proving topological results using intermediate lemmas about discrete objects. We presented two very, but both elegant, discrete proofs of the Poincaré-Miranda Theorem. The first involved the Steinhaus Chessboard Theorem, which states the existence of a particular colored chain in colorings of grids. The second involved a generalization of Sperner's Lemma to polytopes. Such discrete proofs are simpler and more accessible than the higher-level topological proofs of Poincaré-Miranda Theorem. The proof using Polytopal Sperner can also be of use in actually finding a zero.

Possible future work includes finding a discrete proof for Morales's Theorem with the boundary condition $\langle f(x), x \rangle > 0$ for general n . I do not see how to generalize the discrete proof I gave for dimension 2.

Bibliography

De Loera, J., E. Peterson, and F. Su. 2002. A polytopal generalization of sperner's lemma". *Journal of Combinatorial Theory Series A* 100:1 – 26.

Hadamard, J. 1910. Sur quelques applications de l'indice de kronecker. *Introduction to: J Tannery, La The'orie des Fonctions d'une Variable, Hermann, Paris* 6.

Knaster, B., K. Kuratowski, and S. Mazurkiewicz. 1929. Ein beweis des fixpunktsatzes fur n-dimensionale simplex. *Fund Math* 14:132–137.

Kulpa, Wladyslaw. 1997. The poincaré-miranda theorem. *The American Mathematical Monthly* 104(6):pp. 545–550. URL <http://www.jstor.org/stable/2975081>.

Miranda, C. 1940. Un osservazione su una teorema di brouwer. *Boll Union Mat Ital* 527.

Morales, C. 2002. A bolzano's theorem in the new millenium. *Nonlinear Analysis* 51:679 – 691.

Poincaré, H. 1886. Sur les courbes definies par une equation differentielle. *J Math Pures Appl* 85:151–217.

Sperner, E. 1928. Neuer beweis fur die invarianz der dimensionszahl und des gebietes. *Abhandlungen aus dem Mathematisches Seminar, Hamburg Universitat* 6:265 – 272.

Tkacz, Przemyslaw, and Marian Turzański. 2008. An n-dimensional version of steinhaus' chessboard theorem. *Topology and its Applications* 155(4):354 – 361. doi:10.1016/j.topol.2007.07.005. URL <http://www.sciencedirect.com/science/article/pii/S0166864107003033>. Proceedings of the Tenth Prague Symposium on General Topology and its Relations to Modern Analysis and Algebra.