

Regularized Transformation-Optics Cloaking for the Helmholtz Equation: From Partial Cloak to Full Cloak

Jingzhi Li^{*}, Hongyu Liu[†], Luca Rondi[‡], Gunther Uhlmann[§]

Abstract

We develop a very general theory on the regularized approximate invisibility cloaking for the wave scattering governed by the Helmholtz equation in any space dimensions $N \geq 2$ via the approach of transformation optics. There are four major ingredients in our proposed theory: 1). The non-singular cloaking medium is obtained by the push-forwarding construction through a transformation which blows up a subset K_ε in the virtual space, where $\varepsilon \ll 1$ is an asymptotic regularization parameter. K_ε will degenerate to K_0 as $\varepsilon \rightarrow +0$, and in our theory K_0 could be any convex compact set in \mathbb{R}^N , or any set whose boundary consists of Lipschitz hypersurfaces, or a finite combination of those sets. 2). A general lossy layer with the material parameters satisfying certain compatibility integral conditions is employed right between the cloaked and cloaking regions. 3). The contents being cloaked could also be extremely general, possibly including, at the same time, generic mediums and, sound-soft, sound-hard and impedance-type obstacles, as well as some sources or sinks. 4). In order to achieve a cloaking device of compact size, particularly for the case when K_ε is not “uniformly small”, an assembly-by-components, the (ABC) geometry is developed for both the virtual and physical spaces and the blow-up construction is based on concatenating different components.

Within the proposed framework, we show that the scattered wave field u_ε corresponding to a cloaking problem will converge to u_0 as $\varepsilon \rightarrow +0$, with u_0 being the scattered wave field corresponding to a sound-hard K_0 . The convergence result is used to theoretically justify the approximate full and partial invisibility cloaks, depending on the geometry of K_0 . On the other hand, the convergence results are conducted in a much more general setting than what is needed for the invisibility cloaking, so they are of significant mathematical interest for their own sake. As for applications, we construct three types of full and partial cloaks. Some numerical experiments are also conducted to illustrate our theoretical results.

^{*}Faculty of Science, South University of Science and Technology of China, Shenzhen 518055, P. R. China. Email: li.jz@sustc.edu.cn

[†]Department of Mathematics and Statistics, University of North Carolina, Charlotte, NC 28223, USA. Email: hongyu.liuip@gmail.com

[‡]Dipartimento di Matematica e Geoscienze, Università degli Studi di Trieste, Trieste, Italy. Email: rondi@units.it

[§]Department of Mathematics, University of Washington, Seattle, WA 98195, USA and Fondation des Sciences Mathématiques de Paris. Email: gunther@math.washington.edu

Keywords: wave scattering, Helmholtz equation, invisibility cloaking, transformation optics, partial and full cloaks, asymptotic estimates
2010 Mathematics Subject Classification: 35Q60, 35J05, 31B10, 35R30, 78A40

1 Introduction

This paper is concerned with the invisibility cloaking for the wave scattering governed by the Helmholtz equation via the approach of transformation optics [16, 17, 22, 36], which is a rapidly growing scientific field with many potential applications. We refer to [8, 14, 15, 33, 39, 40] and the references therein for discussions of the recent progress on both the theory and experiments.

Let Ω and D be two bounded Lipschitz domains in \mathbb{R}^N , $N \geq 2$, such that $D \Subset \Omega$. Let $\sigma = \sigma(x) = (\sigma^{ij}(x)) \in \mathbb{R}^{N \times N}$, $x \in \mathbb{R}^N$, be a symmetric-matrix valued measurable function such that, for some λ , $0 < \lambda \leq 1$, we have

$$\lambda \|\xi\|^2 \leq \sum_{i,j=1}^N \sigma^{ij}(x) \xi_i \xi_j \leq \lambda^{-1} \|\xi\|^2 \quad \text{for any } \xi \in \mathbb{R}^N \text{ and for a.e. } x \in \mathbb{R}^N. \quad (1.1)$$

Let $q = q_1 + iq_2 = q(x)$, $x \in \mathbb{R}^N$, be a complex-valued bounded measurable function with real and imaginary parts q_1 and q_2 respectively, such that, for some λ , $0 < \lambda \leq 1$, we have

$$q_1(x) \geq \lambda, \quad q_2(x) \geq 0 \quad \text{for a.e. } x \in \mathbb{R}^N. \quad (1.2)$$

Furthermore, we assume that $q(x) = q_0 := 1$ and $\sigma^{ij}(x) = \sigma_0^{ij} := \delta_{ij}$ for $x \in \mathbb{R}^N \setminus \overline{\Omega}$, where δ_{ij} denotes the Kronecker delta function. In the following, (1.1) and (1.2) will be referred to as the *regular conditions* on σ and q , and λ is called the *regular constant*.

Next, we introduce the time-harmonic wave scattering governed by the Helmholtz equation whose weak solution is $u = u(x, d, k)$, $x \in \mathbb{R}^N$, where $d \in \mathbb{S}^{N-1}$, $k \in \mathbb{R}_+$,

$$\begin{cases} \operatorname{div}(\sigma \nabla u) + k^2 q u = 0 & \text{in } \mathbb{R}^N, \\ u(x, d, k) - e^{ikx \cdot d} \text{ satisfies the radiation condition.} \end{cases} \quad (1.3)$$

The last statement in (1.3) means that if one lets $u^s(x, d, k) = u(x, d, k) - e^{ikx \cdot d}$, then

$$\lim_{r \rightarrow \infty} r^{\frac{N-1}{2}} \left(\frac{\partial u^s(x)}{\partial r} - ik u^s(x) \right) = 0, \quad r = \|x\|. \quad (1.4)$$

In the physical situation, (1.3) can be used to describe the time-harmonic acoustic scattering due to an inhomogeneous acoustical medium $(\Omega; \sigma, q)$ located in an otherwise uniformly homogeneous space $(\mathbb{R}^N \setminus \overline{\Omega}; \sigma_0, q_0)$. σ and q , respectively, denote the density tensor and acoustic modulus of the acoustical medium, and $u(x)$ denotes the wave pressure with $U(x, t) := u(x) e^{-ikt}$ representing the wave field satisfying the scalar wave equation

$$q(x) U_{tt}(x, t) - \sum_{i,j=1}^N \frac{\partial}{\partial x_i} \left(\sigma^{ij}(x) \frac{\partial}{\partial x_j} U(x, t) \right) = 0 \quad \text{in } \mathbb{R}^N \times \mathbb{R}.$$

The function $u^i(x) := e^{ikx \cdot d}$ is an incident plane wave with k denoting the wave number and $d \in \mathbb{S}^{N-1}$ denoting the impinging direction. $u(x)$ is called the total wave field and $u^s(x)$ is called scattered wave field, which is the perturbation of the incident plane wave caused by the presence of the inhomogeneity $(\Omega; \sigma, q)$ in the whole space. Indeed, it is easily seen that if there is no presence of the inhomogeneity, u^s will be vanishing. For the particular case with $N = 2$, (1.3) can also be used to describe the transverse-electric (TE) polarized electromagnetic (EM) wave propagation with the presence of an infinitely long cylindrical EM inhomogeneity $(\Omega; \sigma, q)$ (see, e.g., [7]). In this case, $\varepsilon := \Re q$, $\gamma := k \Im q$ and $\mu := \sigma^{-1}$ denote, respectively, the electric permittivity, conductivity and magnetic permeability, where \Re and \Im denote taking the respective real and imaginary parts. We refer to [9, 32] for related physical background. In the rest of the paper, in order to ease the exposition, we stick to the terminologies with the acoustic scattering.

We recall that by a weak solution to (1.3) we mean that $u \in H_{loc}^1(\mathbb{R}^N)$ and that it satisfies

$$\int_{\mathbb{R}^N} \sigma \nabla u \cdot \varphi - k^2 q u \varphi = 0 \quad \text{for any } \varphi \in C_0^\infty(\mathbb{R}^N).$$

The limit in (1.4) has to hold uniformly for every direction $\hat{x} = x/\|x\| \in \mathbb{S}^{N-1}$ and is also known as the *Sommerfeld radiation condition* which characterizes the radiating nature of the scattered wave field u^s (cf. [9, 32]). There exists a unique weak solution $u(x, d, k) = u^- \chi_\Omega + u^+ \chi_{\mathbb{R}^N \setminus \bar{\Omega}} \in H_{loc}^1(\mathbb{R}^N)$ to (1.3), and we refer to Appendix in [27] for a convenient proof. We remark that, if the coefficients are regular enough, (1.3) corresponds to the following classical transmission problem

$$\left\{ \begin{array}{ll} \sum_{i,j=1}^N \frac{\partial}{\partial x_i} \left(\sigma^{ij} \frac{\partial}{\partial x_j} u^-(x, d, k) \right) + k^2 q u^-(x, d, k) = 0 & x \in \Omega, \\ \Delta u^+(x, d, k) + k^2 u^+(x, d, k) = 0 & x \in \mathbb{R}^N \setminus \bar{\Omega}, \\ u^-(x) = u^+(x), \quad \sum_{i,j=1}^N (\nu_i \sigma^{ij} \frac{\partial u^-}{\partial x_j})(x) = (\nu \cdot \nabla u^+)(x) & x \in \partial\Omega, \\ u^+(x, d, k) = e^{ikx \cdot d} + u^s(x, d, k) & x \in \mathbb{R}^N \setminus \bar{\Omega}, \\ \lim_{r \rightarrow \infty} r^{\frac{N-1}{2}} \left(\frac{\partial u^s(x)}{\partial r} - ik u^s(x) \right) = 0 & r = \|x\|, \end{array} \right. \quad (1.5)$$

where $\nu = (\nu_i)_{i=1}^N$ is the outward unit normal vector to $\partial\Omega$.

Furthermore, $u(x)$ admits the following asymptotic development as $\|x\| \rightarrow +\infty$

$$u(x, d, k) = e^{ikx \cdot d} + \frac{e^{ik\|x\|}}{\|x\|^{\frac{N-1}{2}}} u_\infty \left(\frac{x}{\|x\|}, d, k \right) + \mathcal{O} \left(\frac{1}{\|x\|^{\frac{N+1}{2}}} \right). \quad (1.6)$$

In (1.6), $u_\infty(\hat{x}, d, k)$ with $\hat{x} := x/\|x\| \in \mathbb{S}^{N-1}$ is known as the *far-field pattern* or the *scattering amplitude*, which depends on the impinging direction d and wave number k of the incident wave $u^i(x) := e^{ikx \cdot d}$, observation direction \hat{x} , and obviously, also the underlying scattering object $(\Omega; \sigma, q)$. In the following, we shall also write $u_\infty(\hat{x}, d; (\Omega; \sigma, q))$ to

indicate such dependences, noting that we consider k to be fixed and we drop the dependence on k . An important inverse scattering problem arising from practical applications is to recover the medium $(\Omega; \sigma, q)$ by knowing of $u_\infty(\hat{x}, d)$. This inverse problem is of fundamental importance to many areas of science and technology, such as radar and sonar, geophysical exploration, non-destructive testing, and medical imaging to name just a few; see [9, 18] and the references therein. In this work, we shall be mainly concerned with the invisibility cloaking for the inverse scattering problem, which could be generally introduced as follows.

Definition 1.1. Let Ω and D be bounded Lipschitz domains such that $D \Subset \Omega$. $\Omega \setminus \overline{D}$ and D represent, respectively, the cloaking region and the cloaked region. Let Γ and Γ' be two subsets of \mathbb{S}^{N-1} . $(\Omega \setminus \overline{D}; \sigma_c, q_c)$ is said to be an (ideal/perfect) *invisibility cloaking device* for the region D if

$$u_\infty(\hat{x}, d; (\Omega; \sigma_e, q_e)) = 0 \quad \text{for } \hat{x} \in \Gamma, d \in \Gamma', \quad (1.7)$$

where the extended object

$$(\Omega; \sigma_e, q_e) = \begin{cases} \sigma_a, q_a & \text{in } D, \\ \sigma_c, q_c & \text{in } \Omega \setminus \overline{D}, \end{cases}$$

with $(D; \sigma_a, q_a)$ denoting a target medium. If $\Gamma = \Gamma' = \mathbb{S}^{N-1}$, then it is called a *full cloak*, otherwise it is called a *partial cloak* with limited apertures Γ of observation angles, and Γ' of impinging angles.

By Definition 1.1, we have that the cloaking layer $(\Omega \setminus \overline{D}; \sigma_c, q_c)$ makes the target medium $(D; \sigma_a, q_a)$ invisible to the exterior scattering measurements when the detecting waves come from the aperture Γ' and the observations are made in the aperture Γ .

One efficient way of constructing the invisibility cloak that has received significant attentions in recent years is the so-called transformation optics [16, 17, 22, 36]. By taking advantage of the push-forward properties of the material parameters σ and q , the transformation optics approach via a blow-up transformation in constructing an (ideal) invisibility cloak can be simply described as follows. Let $(\Omega; \sigma_0, q_0)$ be selected for constructing the cloaking device, and let $P \in \Omega$ be a point. $(\Omega \setminus P; \sigma_0, q_0)$ lives in the so-called *virtual space*. Suppose that there exists a transformation F which blows up the point P to an open subset D within Ω . The homogeneous virtual space is then pushed-forward to form the cloaking layer $(\Omega \setminus \overline{D}; \sigma_c, q_c)$. The cloaking layer together with a filling-in target medium $(D; \sigma_a, q_a)$ forms the cloaking device, which lives in the so-called *physical space*. Due to the transformation invariance of the Helmholtz equation, it can be heuristically argued that the scattering amplitude in the physical space is the same as the scattering amplitude in the virtual space. Since the scatterer in the virtual space is a singular point P , whose scattering effect is negligible, this implies that the scattering amplitude in the physical space is also vanishing. Here, we would like to emphasize that from a practical viewpoint, the target medium should be arbitrary or as general as possible, and this viewpoint shall be adopted throughout our current study. The

blow-up-a-point construction yields singular cloaking materials, namely, the material parameters violate the regular conditions. The singular media present a great challenge for both theoretical analysis and practical fabrications (cf. [11, 29]). In order to avoid the singular structure, several regularized constructions have been developed. In [10, 12, 38], a truncation of singularities has been introduced. In [20, 21, 26], the ‘blow-up-a-point’ transformation in [17, 22, 36] has been regularized to become the ‘blow-up-a-small-region’ transformation. In the current study, we shall adopt the latter one for the construction of our cloaking device. Nevertheless, as pointed out in [19], the truncation-of-singularity construction and the blow-up-a-small-region construction are equivalent to each other. Hence, all the obtained results in this work equally hold for the truncation-of-singularity construction. Instead of ideal/perfect invisibility, one would consider approximate/near invisibility for a regularized construction; that is, one intends to make the corresponding scattering amplitude due to a regularized cloaking device as small as possible depending on an asymptotically small regularization parameter $\varepsilon \in \mathbb{R}_+$. This is the main subject of study for the present paper.

Due to its practical importance, the approximate cloaking has recently been extensively studied. In [5, 21], approximate cloaking schemes were developed for EIT (electric impedance tomography) which might be regarded as optics at zero frequency. In [6, 4, 20, 23, 28, 26, 34, 35], various near-cloaking schemes were presented for scalar waves governed by the Helmholtz equation. In all the aforementioned work, the constructions of the cloaking layer $(\Omega \setminus \overline{D}; \sigma_c^\varepsilon, q_c^\varepsilon)$ are based on blowing up a uniformly small neighborhood P_ε of a singular point P ; namely, P_ε degenerates to the single point P as $\varepsilon \rightarrow +0$. In order to stabilize and enhance the accuracy of approximation of the near-cloaks, various mechanisms have been developed in those literatures. Particularly, we would like to note that, in [20], it is shown that the regularized approximate cloak is unstable due to the existence of cloak-busting inclusions, and the authors propose to incorporate a special lossy layer to stabilize the approximation. A different lossy layer was proposed and investigated in [23, 28]. The cloaking of impenetrable obstacles, which could be taken as lossy mediums with extreme material parameters, were considered in [5, 6, 4] and [26]. Also, we would like to point out that, in all those studies, the approximate full invisibility cloaks were obtained.

In the present work, we develop a very general theory on the regularized approximate invisibility cloaking for the wave scattering governed by the Helmholtz equation in any space dimensions $N \geq 2$ via the approach of transformation optics. First, the non-singular cloaking medium is obtained by the push-forwarding construction through a transformation which blows up a subset K_ε in the virtual space, with K_ε degenerating to K_0 as $\varepsilon \rightarrow +0$. In our theory, K_0 could be very general. It could be any convex compact subset in \mathbb{R}^N , or any set whose boundary consists of Lipschitz hypersurfaces, or a finite combination of those sets. For example, in \mathbb{R}^3 , it could be a single point, or a line segment, or a bounded planar subset. This includes all the existing studies in the literature by blowing up ‘point-like’ regions as a very special case. Second, in order to stabilize the approximation process, a lossy layer with the material parameters satisfying certain mild compatibility integral conditions is employed right between the

cloaked and cloaking regions. The lossy layer is also very general and could be variable and even be anisotropic. Third, the proposed cloaking scheme is shown to be capable of nearly cloaking an very general content, possibly including, at the same time, generic passive mediums, and sound-soft, sound-hard, and impedance-type obstacles, and some active sources or sinks as well. Finally, in order to achieve a cloaking device of compact size, particularly for the case when K_ε is not ‘point-like’, assembled-by-components (ABC) geometry is developed for both the virtual and physical spaces and the blow-up construction is based on concatenating different components. Within the proposed framework, we show that the scattered wave field u_ε corresponding to a cloaking problem will converge to u_0 as $\varepsilon \rightarrow +0$, with u_0 being the scattered wave field corresponding to a sound-hard K_0 . The convergence result is used to theoretically justify the approximate full and partial invisibility cloaks, depending on the geometry of K_0 . On the other hand, the convergence results are conducted in a much more general setting than what is needed for the invisibility cloaking, so they are of significant mathematical interest for their own sake. As for applications, we construct three types of full and partial cloaks. Some numerical experiments are also conducted to illustrate our theoretical results.

It is interesting to note that in addition to the blow-up-a-single-point construction, the cloaking constructions based on blowing up an arc curve or a planar rectangle are also proposed and investigated in [13, 24], and they respectively yield the so-called electromagnetic wormholes and carpet-cloaking. As discussed earlier, the regularized blow-up-a-single-point construction, namely the blow-up-a-small-region construction, has been extensively studied in the literature. Using the general framework developed in the present work, one can easily construct the regularized electromagnetic wormholes and carpet-cloaking by employing non-singular materials. In this paper, we focus entirely on the transformation optics approach in achieving the cloaks. We would like to mention in passing other promising cloaking techniques which we did not consider in the present study including the one based on anomalous localized resonance [3, 31], and another one based on special (object-dependent) coatings [2].

The rest of the paper is organized as follows. In the next section, we present the general blow-up construction of the proposed regularized cloaks and give some relevant discussions. Section 3 is devoted to the convergence analysis in the virtual space. Section 4 is on the application of the results obtained in Section 3 to the construction of full and partial cloaks in the physical space. In Section 5, we develop the ABC-geometry for both the virtual and physical spaces, and construct three types of full and partial cloaks that are new to the literature. Finally, in Section 6, we give some numerical simulations.

2 General construction of the regularized cloaks

In this section, we shall give the general construction of a regularized cloaking device via the transformation optics approach based on a blow-up mapping between the virtual and the physical spaces. The main purpose of this section is to pave the way for our convergence analysis study in the virtual space that shall be conducted in the next section. We first give a definition of an admissible acoustic configuration.

For any $x \in \mathbb{R}^N$, $N \geq 2$, we denote $x = (x', x_N) \in \mathbb{R}^{N-1} \times \mathbb{R}$ and $x = (x'', x_{N-1}, x_N) \in \mathbb{R}^{N-2} \times \mathbb{R} \times \mathbb{R}$. For any $r > 0$ and any $x \in \mathbb{R}^N$, $B_r(x)$ denotes the Euclidean ball contained in \mathbb{R}^N with radius r and center x , whereas $B'_r(x')$ denotes the Euclidean ball contained in \mathbb{R}^{N-1} with radius r and center x' . Moreover, $B_r = B_r(0)$ and $B'_r = B'_r(0)$. Finally, for any $E \subset \mathbb{R}^N$, we denote $B_r(E) = \bigcup_{x \in E} B_r(x)$.

Definition 2.1. We say that $K \subset \mathbb{R}^N$ is a *scatterer* if K is compact and $G = \mathbb{R}^N \setminus K$ is connected.

A scatterer $K \subset \overline{B_R}$, for some $R > 0$, is *regular* if the immersion $W^{1,2}(B_{R+1} \setminus K) \rightarrow L^2(B_{R+1} \setminus K)$ is compact.

We say that a scatterer K is *Lipschitz-regular* if, for some positive constants r , L_1 and L_2 , for any $x \in \partial K$ there exists a bi-Lipschitz function $\Phi_x : B_r(x) \rightarrow \mathbb{R}^N$ such that the following properties hold. First, for any $z_1, z_2 \in B_r(x)$ we have

$$L_1 \|z_1 - z_2\| \leq \|\Phi_x(z_1) - \Phi_x(z_2)\| \leq L_2 \|z_1 - z_2\|.$$

Second, $\Phi_x(x) = 0$ and $\Phi_x(\partial K \cap B_r(x)) \subset \pi = \{y \in \mathbb{R}^N : y_N = 0\}$.

A scatterer K is said to be *Lipschitz* if, for some positive constants r and L , the following assumptions hold.

For any $x \in \partial K$, there exists a function $\varphi : \mathbb{R}^{N-1} \rightarrow \mathbb{R}$, such that $\varphi(0) = 0$ and which is Lipschitz with Lipschitz constant bounded by L , such that, up to a rigid change of coordinates, we have $x = 0$ and

$$B_r(x) \cap \partial K \subset \{y \in B_r(x) : y_N = \varphi(y')\}.$$

We say that $x \in \partial K$ belongs to the interior of ∂K if there exists δ , $0 < \delta \leq r$, such that $B_\delta(x) \cap \partial K = \{y \in B_\delta(x) : y_N = \varphi(y')\}$. Otherwise we say that x belongs to the boundary of ∂K . We remark that the boundary of ∂K might be empty and that, if $x \in \partial K$ belongs to the interior of ∂K , then K may lie at most on one side of ∂K , that is $B_\delta(x) \cap K = B_\delta(x) \cap \partial K$, or $B_\delta(x) \cap K = \{y \in B_\delta(x) : y_N \geq \varphi(y')\}$, or $B_\delta(x) \cap K = \{y \in B_\delta(x) : y_N \leq \varphi(y')\}$.

For any x belonging to the boundary of ∂K , we assume that there exists another function $\varphi_1 : \mathbb{R}^{N-2} \rightarrow \mathbb{R}$, such that $\varphi_1(0) = 0$ and which is Lipschitz with Lipschitz constant bounded by L , such that, up to the previous rigid change of coordinates, we have $x = 0$ and

$$B_r(x) \cap \partial K = \{y \in B_r(x) : y_N = \varphi(y'), y_{N-1} \leq \varphi_1(y'')\}.$$

Finally, for any $x \in \partial K$, let $e_1(x), \dots, e_N(x)$ be the unit vectors representing the orthonormal base of the coordinate system for which the previous representations hold. Then we assume that $e_N(x)$ is a Lipschitz function of $x \in \partial K$, with Lipschitz constant bounded by L , and $e_{N-1}(x)$ is a Lipschitz function of x , as x varies on the boundary of ∂K , with Lipschitz constant bounded by L .

Properties of Lipschitz scatterers are thoroughly investigated in [30, Section 4]. Let us just notice that a Lipschitz scatterer K is Lipschitz-regular. Furthermore, a Lipschitz-regular scatterer $K \subset \overline{B_R}$ is regular and the immersion $W^{1,2}(B_{R+1} \setminus K) \rightarrow L^2(\partial K)$ is

compact. Notice that for a connected component \tilde{K} of K with empty interior, with a slight abuse of notation, with $\partial\tilde{K}$ we denote two copies of \tilde{K} , $(\tilde{K}^+, \tilde{K}^-)$, and by $L^2(\partial\tilde{K})$ we denote the couple $(u^+, u^-) \in L^2(\tilde{K}^+) \times L^2(\tilde{K}^-)$. In such a way we can define the trace of a function $u \in W^{1,2}(B_{R+1} \setminus K)$ on both sides of \tilde{K} .

Definition 2.2. We fix $k > 0$. An acoustic configuration $\mathcal{C} = (K_1, K_2, K_3, s, \sigma, q, h, H)$ is *admissible* if the following assumptions hold.

There exist three scatterers K_1, K_2, K_3 which are pairwise disjoint (possibly some or all of them may be the empty set) and such that K_2 is regular and K_3 is Lipschitz-regular. We set $K = K_1 \cup K_2 \cup K_3$.

Let $s = s_1 + is_2 = s(x)$, $x \in \partial K_3$, be a complex-valued bounded \mathcal{H}^{N-1} -measurable function, with real and imaginary part s_1 and s_2 respectively, such that

$$s_1(x) \leq 0 \quad \text{and} \quad s_2(x) \geq 0 \quad \text{for } \mathcal{H}^{N-1}\text{-a.e. } x \in \partial K_3.$$

Again, on a connected component \tilde{K} of K_3 with empty interior, $s \in L^\infty(\partial\tilde{K})$ means $(s^+, s^-) \in L^\infty(\tilde{K}^+) \times L^\infty(\tilde{K}^-)$.

Let $\sigma = \sigma(x)$, $x \in \mathbb{R}^N \setminus K$, be an $N \times N$ symmetric matrix whose entries are real-valued measurable functions such that, for some λ , $0 < \lambda \leq 1$, we have

$$\lambda \|\xi\|^2 \leq \sigma(x) \xi \cdot \xi \leq \lambda^{-1} \|\xi\|^2 \quad \text{for any } \xi \in \mathbb{R}^N \text{ and for a.e. } x \in \mathbb{R}^N \setminus K.$$

Let $q = q_1 + iq_2 = q(x)$, $x \in \mathbb{R}^N \setminus K$, be a complex-valued bounded measurable function, with real and imaginary part q_1 and q_2 respectively, such that, for some λ , $0 < \lambda \leq 1$, we have

$$q_1(x) \geq \lambda \quad \text{and} \quad q_2(x) \geq 0 \quad \text{for a.e. } x \in \mathbb{R}^N \setminus K.$$

Furthermore, we assume that

$$\sigma(x) \equiv I \quad \text{and} \quad q(x) \equiv 1 \quad \text{for any } x \text{ outside a compact subset.}$$

The source term $(h, H) \in L^2(\mathbb{R}^N \setminus K, \mathbb{C} \times \mathbb{C}^N)$ and it has compact support.

Finally, we require that the following scattering problem has only a trivial weak solution

$$\begin{cases} \operatorname{div}(\sigma \nabla u) + k^2 q u = 0 & \text{in } \mathbb{R}^N \setminus K, \\ u = 0 & \text{on } \partial K_1, \\ \sigma \nabla u \cdot \nu = 0 & \text{on } \partial K_2, \\ \sigma \nabla u \cdot \nu - s u = 0 & \text{on } \partial K_3, \\ u \text{ satisfies the radiation condition,} \end{cases} \quad (2.1)$$

where ν denotes the exterior normal to $G = \mathbb{R}^N \setminus K$.

Physically speaking, we have that K_1 is a sound-soft scatterer, K_2 is sound-hard and we have an impedance boundary condition on K_3 . The admissible configuration \mathcal{C} represents the scattering object for our study, which consists of the impenetrable obstacle (K, s) , the passive medium (σ, q) , and the active source/sink (h, H) . We note the following result that can be proved in a standard way (cf. [27]).

Proposition 2.1. *Let u^i be an entire solution to the Helmholtz equation $\Delta u + k^2 u = 0$ in \mathbb{R}^N . Let us consider an admissible configuration \mathcal{C} in \mathbb{R}^N . Then there exists a unique weak solution to the following scattering problem*

$$\begin{cases} \operatorname{div}(\sigma \nabla u) + k^2 q u = -h + \operatorname{div}(H) & \text{in } \mathbb{R}^N \setminus K, \\ u = 0 & \text{on } \partial K_1, \\ \sigma \nabla u \cdot \nu = 0 & \text{on } \partial K_2, \\ \sigma \nabla u \cdot \nu - s u = 0 & \text{on } \partial K_3, \\ u - u^i \text{ satisfies the radiation condition.} \end{cases} \quad (2.2)$$

If we take $u^i(x) = e^{ikx \cdot d}$, $x \in \mathbb{R}^N$, to be the plane wave, then the solution u to (2.2) has exactly the same asymptotic development as that in (1.6), and we denote by $u_\infty(\hat{x}, d; \mathcal{C})$, $\hat{x} \in \mathbb{S}^{N-1}$, the far-field pattern of the scattered field u^s .

Next, we present a lemma with some key ingredients of the transformation optics, the proofs of which are available in [14, 20, 26]. The main remark is that the definition of an admissible configuration is stable under bi-Lipschitz transformations.

Lemma 2.1. *Let Ω and $\tilde{\Omega}$ be two Lipschitz domains in \mathbb{R}^N and $\tilde{x} = F(x) : \Omega \rightarrow \tilde{\Omega}$ be a bi-Lipschitz and orientation-preserving mapping.*

Let $\mathcal{C} = (\Omega; K_1, K_2, K_3, s, \sigma, q, h, H)$ be an admissible configuration in Ω . For simplicity we assume that K and the supports of h and H are contained in Ω . We let the push-forwarded configuration be defined as

$$\begin{aligned} \tilde{\mathcal{C}} = (\tilde{\Omega}; \tilde{K}_1, \tilde{K}_2, \tilde{K}_3, \tilde{s}, \tilde{\sigma}, \tilde{q}, \tilde{h}, \tilde{H}) = F_*(\Omega; K_1, K_2, K_3, s, \sigma, q, h, H) := \\ (F(\Omega); F(K_1), F(K_2), F(K_3), F_*s, F_*\sigma, F_*q, F_*h, F_*H). \end{aligned} \quad (2.3)$$

Notice that \tilde{K}_1 is a scatterer, whereas \tilde{K}_2 is a regular scatterer and \tilde{K}_3 is a Lipschitz-regular scatterer. Moreover,

$$\tilde{s}(\tilde{x}) = F_*s(\tilde{x}) := \frac{s(x)}{|\det(D_\tau F(x))|} \Big|_{x=F^{-1}(\tilde{x})}, \quad (2.4)$$

where $D_\tau F$ denotes the tangential component of the Jacobian matrix of F . We also have

$$\begin{aligned} \tilde{\sigma}(\tilde{x}) = F_*\sigma(\tilde{x}) &:= \frac{DF(x) \cdot \sigma(x) \cdot DF(x)^T}{|\det(DF(x))|} \Big|_{x=F^{-1}(\tilde{x})}, \\ \tilde{q}(\tilde{x}) = F_*q(\tilde{x}) &:= \frac{q(x)}{|\det(DF(x))|} \Big|_{x=F^{-1}(\tilde{x})}, \end{aligned} \quad (2.5)$$

where DF denotes the Jacobian matrix of F . Finally,

$$\begin{aligned} \tilde{h}(\tilde{x}) = F_*h(\tilde{x}) &:= \frac{h(x)}{|\det(DF(x))|} \Big|_{x=F^{-1}(\tilde{x})}, \\ \tilde{H}(\tilde{x}) = F_*H(\tilde{x}) &:= \frac{DF(x) \cdot H(x)}{|\det(DF(x))|} \Big|_{x=F^{-1}(\tilde{x})}. \end{aligned} \quad (2.6)$$

Then $u \in H^1(\Omega \setminus K)$ solves the Helmholtz equation

$$\begin{cases} \nabla \cdot (\sigma \nabla u) + k^2 q u = -h + \nabla \cdot H & \text{in } \Omega \setminus K, \\ u = 0 & \text{on } \partial K_1, \\ \sigma \nabla u \cdot \nu = 0 & \text{on } \partial K_2, \\ \sigma \nabla u \cdot \nu - s u = 0 & \text{on } \partial K_3, \end{cases}$$

if and only if the pull-back field $\tilde{u} = (F^{-1})^* u := u \circ F^{-1} \in H^1(\tilde{\Omega} \setminus \tilde{K})$ solves

$$\begin{cases} \tilde{\nabla} \cdot (\tilde{\sigma} \nabla \tilde{u}) + k^2 \tilde{q} \tilde{u} = -\tilde{h} + \tilde{\nabla} \cdot \tilde{H} & \text{in } \tilde{\Omega} \setminus \tilde{K}, \\ \tilde{u} = 0 & \text{on } \partial \tilde{K}_1, \\ \tilde{\sigma} \nabla \tilde{u} \cdot \nu = 0 & \text{on } \partial \tilde{K}_2, \\ \tilde{\sigma} \nabla \tilde{u} \cdot \nu - \tilde{s} \tilde{u} = 0 & \text{on } \partial \tilde{K}_3. \end{cases}$$

We have made use of ∇ and $\tilde{\nabla}$ to distinguish the differentiations respectively in x - and \tilde{x} -coordinates.

As a consequence of Lemma 2.1, one can directly verify that if $F : \Omega \rightarrow \Omega$ is a bi-Lipschitz map with $F|_{\partial\Omega} = \text{Identity}$, then the push-forward of an admissible configuration is again an admissible configuration and

$$u_\infty(\hat{x}, d; \mathcal{C}) = u_\infty(\hat{x}, d; \tilde{\mathcal{C}}), \quad \text{for any } \hat{x}, d \in \mathbb{S}^{N-1}. \quad (2.7)$$

The observation (2.7) is of critical importance for our following general construction of the cloaking scheme. Finally, let us point out that the following quantities remain unchanged under the push-forward

$$\int_{\Omega} (q_i)^{-1} |h|^2 = \int_{\tilde{\Omega}} (\tilde{q}_i)^{-1} |\tilde{h}|^2, \quad i = 1, 2, \quad \text{and} \quad \int_{\Omega} (\sigma)^{-1} H \cdot \overline{H} = \int_{\tilde{\Omega}} (\tilde{\sigma})^{-1} \tilde{H} \cdot \overline{\tilde{H}}.$$

With the above preparations, we are ready to present the general construction of our proposed cloaks. By a bit abuse of notation, we let from now on Ω , D and Σ be the closures of three bounded Lipschitz domains in \mathbb{R}^N such that $\mathbb{R}^N \setminus \Omega$ is connected and $\Sigma \subset \overset{\circ}{D} \Subset \overset{\circ}{\Omega}$. Let K_0 be a compact subset in \mathbb{R}^N , and K_ε be an ε -neighborhood of K_0 . Both K_0 and K_ε shall be made precise in the next section. We assume there exists a bi-Lipschitz and orientation-preserving mapping F_ε such that

$$F_\varepsilon = \text{Identity on } \mathbb{R}^N \setminus \Omega; \quad F_\varepsilon^{(1)} \text{ on } \Omega \setminus K_\varepsilon; \quad F_\varepsilon^{(2)} \text{ on } K_\varepsilon \quad (2.8)$$

with

$$F_\varepsilon^{(2)}(K_{\varepsilon/2}) = \Sigma, \quad F_\varepsilon^{(2)}(K_\varepsilon) = D, \quad F_\varepsilon^{(1)}(\Omega \setminus K_\varepsilon) = \Omega \setminus D. \quad (2.9)$$

Let, in the physical space, $\tilde{\mathcal{C}}^\varepsilon = (\Sigma_1, \Sigma_2, \Sigma_3, s, \tilde{\sigma}^\varepsilon, \tilde{q}^\varepsilon, h, H)$ be an admissible configuration as described in what follows. Set $\tilde{\Sigma} = \Sigma_1 \cup \Sigma_2 \cup \Sigma_3$. The following properties are required. First, $\tilde{\Sigma} \subset \Sigma$ and h and H are supported in Σ . Second, we have

$$(\Omega \setminus D; \tilde{\sigma}^\varepsilon, \tilde{q}^\varepsilon) = (F_\varepsilon)_*(\Omega \setminus K_\varepsilon; I, 1); \quad \tilde{\sigma}^\varepsilon(x) = I, \quad \tilde{q}^\varepsilon(x) = 1 \quad \text{for a.e. } x \in \mathbb{R}^N \setminus \Omega, \quad (2.10)$$

and

$$(D \setminus \Sigma; \tilde{\sigma}^\varepsilon, \tilde{q}^\varepsilon) = (F_\varepsilon)_*(K_\varepsilon \setminus K_{\varepsilon/2}; \sigma_l^\varepsilon, q_l^\varepsilon), \quad (2.11)$$

where $(K_\varepsilon \setminus K_{\varepsilon/2}; \sigma_l^\varepsilon, q_l^\varepsilon)$ is a lossy layer that is admissible and shall also be made precise in the subsequent sections. In the physical space, $(\Omega \setminus D; \tilde{\sigma}^\varepsilon, \tilde{q}^\varepsilon)$ is the cloaking layer, and $(D \setminus \Sigma; \tilde{\sigma}^\varepsilon, \tilde{q}^\varepsilon)$ is a layer obtained with specially chosen parameters σ_l^ε and q_l^ε . Σ is the cloaked region where the target objects are located, and they include the impenetrable obstacle $(\tilde{\Sigma}, s)$, the medium $(\Sigma \setminus \bigcup_{l=1}^3 \Sigma_l; \tilde{\sigma}^\varepsilon, \tilde{q}^\varepsilon)$ and the active source/sink (h, H) . Here, we would like to emphasize that in our cloaking scheme, if h and H are zero, namely no source/sink is present inside the cloaked region, then $(\Sigma \setminus \bigcup_{l=1}^3 \Sigma_l; \tilde{\sigma}^\varepsilon, \tilde{q}^\varepsilon)$ and $(\tilde{\Sigma}, s)$ could be arbitrary except for admissibility; and only when there is a source/sink present, we would require some generic condition on the cloaked medium $(\Sigma \setminus \bigcup_{l=1}^3 \Sigma_l; \tilde{\sigma}^\varepsilon, \tilde{q}^\varepsilon)$. We finally notice that the configuration inside Σ do not depend on ε , that is $\tilde{\Sigma}$, s , h and H , and the coefficients $\tilde{\sigma}^\varepsilon$ and \tilde{q}^ε inside Σ , do not depend on ε .

The scattering problem corresponding to the cloaking construction described above is given by

$$\begin{cases} \operatorname{div}(\tilde{\sigma}^\varepsilon \nabla \tilde{u}_\varepsilon) + k^2 \tilde{q}^\varepsilon \tilde{u}_\varepsilon = -h + \operatorname{div}(H) & \text{in } \mathbb{R}^N \setminus \bigcup_{l=1}^3 \Sigma_l, \\ \tilde{u}_\varepsilon = 0 & \text{on } \partial \Sigma_1, \\ \tilde{\sigma}^\varepsilon \nabla \tilde{u}_\varepsilon \cdot \nu = 0 & \text{on } \partial \Sigma_2, \\ \tilde{\sigma}^\varepsilon \nabla \tilde{u}_\varepsilon \cdot \nu - s \tilde{u}_\varepsilon = 0 & \text{on } \partial \Sigma_3, \\ \tilde{u}_\varepsilon - u^i \text{ satisfies the radiation condition.} \end{cases} \quad (2.12)$$

We assume that the configuration is admissible, therefore there exists a unique solution $\tilde{u}_\varepsilon \in H_{loc}^1(\mathbb{R}^N \setminus \bigcup_{l=1}^3 \Sigma_l)$ to (2.12). In the sequel, we let $\tilde{u}_\infty^\varepsilon$ denote the corresponding scattering amplitude.

One of the main results of this work is to show the convergence of \tilde{u}_ε (and hence $\tilde{u}_\infty^\varepsilon$), and then apply it to derive the approximate cloaking in various settings. To that end, in the virtual space, the admissible configuration $\mathcal{C}^\varepsilon = (K_1^\varepsilon, K_2^\varepsilon, K_3^\varepsilon, s^\varepsilon, \sigma^\varepsilon, q^\varepsilon, h^\varepsilon, H^\varepsilon)$ is given by

$$\mathcal{C}^\varepsilon = F_*^{-1}(\tilde{\mathcal{C}}^\varepsilon),$$

that is

$$F_\varepsilon^{(2)}(K_l^\varepsilon) = \Sigma_l, \quad l = 1, 2, 3, \quad (2.13)$$

and $K^\varepsilon = K_1^\varepsilon \cup K_2^\varepsilon \cup K_3^\varepsilon \subset K_{\varepsilon/2}$. Furthermore,

$$\sigma^\varepsilon(x) = I, \quad q^\varepsilon(x) = 1 \quad \text{for a.e. } x \in \mathbb{R}^N \setminus K_\varepsilon,$$

and

$$\sigma^\varepsilon = \sigma_l^\varepsilon, \quad q^\varepsilon = q_l^\varepsilon \quad \text{in } K_\varepsilon \setminus K_{\varepsilon/2}.$$

We let $u_\varepsilon = (F_\varepsilon)^* \tilde{u}_\varepsilon \in H_{loc}^1(\mathbb{R}^N \setminus \bigcup_{l=1}^3 K_l^\varepsilon)$ and, by Lemma 2.1, it is straightforward to verify that u_ε is the unique solution to

$$\begin{cases} \operatorname{div}(\sigma^\varepsilon \nabla u_\varepsilon) + k^2 q^\varepsilon u_\varepsilon = -h^\varepsilon + \operatorname{div}(H^\varepsilon) & \text{in } \mathbb{R}^N \setminus \bigcup_{l=1}^3 K_l^\varepsilon, \\ u_\varepsilon = 0 & \text{on } \partial K_1^\varepsilon, \\ \sigma^\varepsilon \nabla u_\varepsilon \cdot \nu = 0 & \text{on } \partial K_2^\varepsilon, \\ \sigma^\varepsilon \nabla u_\varepsilon \cdot \nu - s^\varepsilon u_\varepsilon = 0 & \text{on } \partial K_3^\varepsilon, \\ u_\varepsilon - u^i \text{ satisfies the radiation condition.} \end{cases} \quad (2.14)$$

We notice that (2.12) describes the scattering in the physical space corresponding to the cloaking construction, whereas (2.14) describes the scattering in the virtual space. Clearly, we have $u_\varepsilon = \tilde{u}_\varepsilon$ outside a sufficiently large ball. Hence, in order to study the convergence of \tilde{u}_ε , it suffices for us to study the convergence of u_ε , which is the main task of Section 3 in the sequel. We note the following peculiar structure of the virtual scattering problem (2.14) for our subsequent study. The scattering objects, including the passive penetrable medium and impenetrable obstacles $\bigcup_{l=1}^3 K_l^\varepsilon$, and the active source/sink are included into the innermost region $K_{\varepsilon/2}$, and then they are enclosed by a lossy layer $(K_\varepsilon \setminus K_{\varepsilon/2}; \sigma_l^\varepsilon, q_l^\varepsilon)$. When K_ε is uniformly small, namely K_ε will degenerate to a singular point as $\varepsilon \rightarrow +0$, this is the case that has been extensively investigated in [5, 6, 4, 20, 21, 23, 28]. As emphasized in the introduction, we shall extend such studies to an extremely general setting, especially K_ε could be ‘partially small’, as will be seen in our subsequent study. The critical scaling arguments developed in [5, 6, 4, 20, 21, 23, 28] cannot be adapted to treating the much more challenging cases of the current study.

3 Analysis in the virtual space

This section is devoted to the convergence analysis of the virtual scattering problem (2.14). However, our study shall be conducted in a much more general setting than is needed for the cloaking purpose.

Let K_0 be a scatterer in \mathbb{R}^N . Let us denote by $d : \mathbb{R}^N \rightarrow [0, +\infty)$ the distance function from K_0 defined as follows

$$d(x) = \operatorname{dist}(x, K_0) \quad \text{for any } x \in \mathbb{R}^N.$$

We assume that there exists a Lipschitz function $\tilde{d} : \mathbb{R}^N \rightarrow [0, +\infty)$ such that the following properties are satisfied.

First, there exist constants a and b , $0 < a \leq 1 \leq b$, such that

$$ad(x) \leq \tilde{d}(x) \leq bd(x) \quad \text{for any } x \in \mathbb{R}^N.$$

For any $\varepsilon > 0$, let us call $K_\varepsilon = \{x \in \mathbb{R}^N : \tilde{d}(x) \leq \varepsilon\}$. For some constants $\varepsilon_0 > 0$, $p > 2$, $C_1 > 0$ and $R > 0$, we require that for any ε , $0 < \varepsilon \leq \varepsilon_0$, $K_\varepsilon \subset \overline{B_R}$, $\mathbb{R}^N \setminus K_\varepsilon$ is

connected and

$$\|u\|_{L^p(B_{R+1} \setminus K_\varepsilon)} \leq C_1 \|u\|_{H^1(B_{R+1} \setminus K_\varepsilon)} \quad \text{for any } u \in H^1(B_{R+1} \setminus K_\varepsilon).$$

We notice that, under these assumptions, K_ε , for any $0 \leq \varepsilon \leq \varepsilon_0$, is a regular scatterer. A simple sufficient condition for these assumptions to hold is that K_0 is a compact convex set. In fact, clearly we have that $\mathbb{R}^N \setminus K_0$ is connected. Then, we can take $\tilde{d} = d$ or the distance from K_0 with respect to any norm on \mathbb{R}^N , not only with respect to the Euclidean one. Then, for any $\varepsilon > 0$, $K_\varepsilon = \overline{B_\varepsilon(K_0)}$, clearly with respect to the chosen norm. For any $\varepsilon > 0$, we have that $\overline{B_\varepsilon(K)}$ is still a convex set, therefore $\mathbb{R}^N \setminus \overline{B_\varepsilon(K_0)}$ is connected and satisfies a cone condition with a cone independent on ε . Hence also the other required properties are satisfied, for instance using [1, Theorem 5.4].

Another sufficient condition is that K_0 is a Lipschitz scatterer, see [30, Section 4]. Finally, K_0 may be the union of a finite number of pairwise disjoint compact convex sets and Lipschitz scatterers.

For any fixed ε , $0 < \varepsilon \leq \varepsilon_0$, let us assume that $\{K_1^\varepsilon, K_2^\varepsilon, K_3^\varepsilon, s^\varepsilon, \sigma^\varepsilon, q^\varepsilon, h^\varepsilon, H^\varepsilon\}$ is an admissible configuration.

Moreover, we require that one of the following two assumptions holds.

Assumption 1. $\{K_1^\varepsilon, K_2^\varepsilon, K_3^\varepsilon, s^\varepsilon, \sigma^\varepsilon, q^\varepsilon, h^\varepsilon, H^\varepsilon\}$ is an admissible configuration with the following properties. First, $K^\varepsilon = K_1^\varepsilon \cup K_2^\varepsilon \cup K_3^\varepsilon \subset K_{\varepsilon/2}$. Second, the behavior of σ^ε and q^ε is different in the following three regions, $K_{\varepsilon/2} \setminus K^\varepsilon$, $K_\varepsilon \setminus K_{\varepsilon/2}$ and $\mathbb{R}^N \setminus K_\varepsilon$.

- a) We have that $\sigma^\varepsilon(x) = I$ and $q^\varepsilon(x) = 1$ for almost every $x \in \mathbb{R}^N \setminus K_\varepsilon$.
- b) There exist a continuous nondecreasing function $\omega_1 : (0, \varepsilon_0] \rightarrow (0, +\infty)$, such that $\lim_{s \rightarrow 0^+} \omega_1(s) = 0$, and positive constants E_1, E'_1, Λ , and E_2 such that for almost any $x \in K_\varepsilon \setminus K_{\varepsilon/2}$

$$0 < q_1^\varepsilon(x) \leq E_1(\omega_1(\varepsilon))^{-1} \quad \text{and} \quad 0 < E'_1(\omega_1(\varepsilon))^{-1} \leq q_2^\varepsilon(x). \quad (3.1)$$

Furthermore

$$\sigma^\varepsilon(x) \xi \cdot \xi \leq \Lambda \|\xi\|^2 \quad \text{for any } \xi \in \mathbb{R}^N \text{ and for a.e. } x \in K_\varepsilon \setminus K_{\varepsilon/2} \quad (3.2)$$

and

$$\frac{1}{\varepsilon^2} \sigma^\varepsilon(x) \nabla \tilde{d}(x) \cdot \nabla \tilde{d}(x) \leq E_2 \quad \text{for a.e. } x \in K_\varepsilon \setminus K_{\varepsilon/2}. \quad (3.3)$$

Finally we require that

$$\lim_{\varepsilon \rightarrow 0^+} \int_{K_\varepsilon \setminus K_{\varepsilon/2}} |q^\varepsilon| = 0. \quad (3.4)$$

- c) There exists a positive constant E_3 such that

$$0 < \sup_{K_{\varepsilon/2} \setminus K^\varepsilon} q_1^\varepsilon \leq E_3 \inf_{K_{\varepsilon/2} \setminus K^\varepsilon} q_2^\varepsilon.$$

We assume that $(h^\varepsilon, H^\varepsilon)(x) = 0$ for almost every $x \in \mathbb{R}^N \setminus K_{\varepsilon/2}$. Moreover, we have that

$$\int_{K_{\varepsilon/2} \setminus K^\varepsilon} (k^2 q_2^\varepsilon)^{-1} |h^\varepsilon|^2 \leq E_3 \quad \text{and} \quad \int_{K_{\varepsilon/2} \setminus K^\varepsilon} (\sigma^\varepsilon)^{-1} H^\varepsilon \cdot \overline{H^\varepsilon} \leq E_3. \quad (3.5)$$

Here the constants E_1, E'_1, Λ, E_2 and E_3 do not depend on ε .

We remark that the previously stated assumption, essentially because $q_2^\varepsilon > 0$ in $K_\varepsilon \setminus K^\varepsilon$, implies that the corresponding problem (2.1) has only the trivial solution without any further assumption on the obstacles $K_1^\varepsilon, K_2^\varepsilon, K_3^\varepsilon$ and the coefficients s^ε and $\sigma^\varepsilon, q^\varepsilon$.

Assumption 2. Assumption 2 coincides with Assumption 1 except for point c) which is replaced by the following.

c) We assume that $H^\varepsilon \equiv 0$ and that $h^\varepsilon(x) = 0$ for almost every $x \in \mathbb{R}^N \setminus K_{\varepsilon/2}$. Moreover, there exists a positive constant E_3 such that

$$\int_{K_{\varepsilon/2} \setminus K^\varepsilon} (k^2 q_2^\varepsilon)^{-1} |h^\varepsilon|^2 \leq E_3. \quad (3.6)$$

Notice that the above condition means that $q_2^\varepsilon > 0$ almost everywhere on the set $\{h^\varepsilon \neq 0\}$ and that the integral is actually performed on such a set.

Remark 3.1. Let us point out here the main differences between these two assumptions. In Assumption 2 we do not impose any condition on the coefficients and scatterers inside $K_{\varepsilon/2}$ except for the indirect condition in (3.6). In particular, if there are no sources, then no condition at all is required for the configuration inside $K_{\varepsilon/2}$ except for its admissibility. The drawback is that the kind of sources we can allow in Assumption 2 is more limited than those considered in Assumption 1.

Let us finally notice that, only for Assumption 1, we may replace (3.3) with the following weaker condition

$$\lim_{\varepsilon \rightarrow 0^+} \frac{1}{\varepsilon^2} \int_{K_\varepsilon \setminus K_{\varepsilon/2}} \sigma^\varepsilon \nabla \tilde{d} \cdot \nabla \tilde{d} = 0. \quad (3.7)$$

We shall keep fixed throughout this section two functions $\phi_1, \phi_2 \in C^\infty(\mathbb{R})$ such that they are nondecreasing and ϕ_1 is identically equal to 0 on a neighborhood of $(-\infty, 3/4]$ and identically equal to 1 on a neighborhood of $[1, +\infty)$, whereas ϕ_2 is identically equal to 0 on a neighborhood of $(-\infty, 1/2]$ and identically equal to 1 on a neighborhood of $[3/4, +\infty)$. Also for any symmetric positive definite matrix σ , we define $\sqrt{\sigma}$ the symmetric positive definite matrix such that $\sqrt{\sigma} \cdot \sqrt{\sigma} = \sigma$.

Let us also fix $\varepsilon_n, 0 < \varepsilon_n \leq \varepsilon_0, n \in \mathbb{N}$, a decreasing sequence of positive numbers such that $\lim_n \varepsilon_n = 0$. For simplicity we denote

$$\begin{aligned} K_n &= K_{\varepsilon_n} \quad \text{and} \quad H_n = K_{\varepsilon_n/2} \quad \text{and} \quad J_n = K_{3\varepsilon_n/4}, \\ \{K_1^{\varepsilon_n}, K_2^{\varepsilon_n}, K_3^{\varepsilon_n}, s^{\varepsilon_n}, \sigma^{\varepsilon_n}, q^{\varepsilon_n}, h^{\varepsilon_n}, H^{\varepsilon_n}\} &= \{K_1^n, K_2^n, K_3^n, s^n, \sigma^n, q^n, h^n, H^n\}, \\ K^n &= K_1^n \cup K_2^n \cup K_3^n = K^{\varepsilon_n}. \end{aligned}$$

We begin with the following result where a Mosco-type convergence is proved.

Lemma 3.1. *Under the previous assumptions, the following two properties hold.*

- i) *Let us consider a subsequence ε_{n_l} and a sequence $u_l \in H^1(B_{R+1} \setminus H_{n_l})$, $l \in \mathbb{N}$. Let us consider $(u_l, \sqrt{\sigma^{n_l}} \nabla u_l) \in L^2(B_{R+1}, \mathbb{R}^{N+1})$ by extending u_l and $\sqrt{\sigma^{n_l}} \nabla u_l$ to 0 in H_{n_l} . If $(u_l, \sqrt{\sigma^{n_l}} \nabla u_l (1 - \chi_{J_{n_l}}))$ converges weakly to (u, V) in $L^2(B_{R+1}, \mathbb{R}^{N+1})$ as $l \rightarrow \infty$, then $u \in H^1(B_{R+1} \setminus K_0)$ and $V = \nabla u$ in $B_{R+1} \setminus K_0$.*
- ii) *For any $\varphi \in H^1(B_{R+1} \setminus K_0)$ such that φ is bounded, there exists a sequence $\varphi_n \in H^1(B_{R+1})$, $n \in \mathbb{N}$, such that $\varphi_n = 0$ in J_n and $(\varphi_n, \sqrt{\sigma^n} \nabla \varphi_n)$ converges strongly to $(\varphi, \nabla \varphi)$ in $L^2(B_{R+1}, \mathbb{R}^{N+1})$ as $n \rightarrow \infty$, where φ and $\nabla \varphi$ are extended to 0 in K_0 .*

Proof. We begin by proving i). Let D be any open subset of B_{R+1} such that $\overline{D} \cap K_0 = \emptyset$. There exists $\bar{l} \in \mathbb{N}$ such that for any $l \geq \bar{l}$ we have that, in D , $(u_l, \sqrt{\sigma^{n_l}} \nabla u_l (1 - \chi_{J_{n_l}})) = (u_l, \nabla u_l)$. Therefore $V = \nabla u$ in D and we may easily conclude that $u \in H^1(B_{R+1} \setminus K_0)$ and $V = \nabla u$ in $B_{R+1} \setminus K_0$. Moreover, v and V are 0 almost everywhere in K_0 .

For what concerns ii), we define $\chi_n = \phi_1(\tilde{d}/\varepsilon_n)$ and $\varphi_n = \chi_n \varphi$. We immediately obtain that φ_n is identically 0 in J_n and that $\varphi_n = \varphi$ in $B_{R+1} \setminus K_n$. Clearly $\varphi_n \in H^1(B_{R+1})$ and, as $n \rightarrow \infty$, φ_n converges to φ in $L^2(B_{R+1})$. Then we need to estimate

$$\int_{B_{R+1}} \|\sqrt{\sigma^n} \nabla \varphi_n - \nabla \varphi\|^2 \leq \int_{K_n \setminus K_0} \|\nabla \varphi\|^2 + \int_{K_n \setminus H_n} \|\sqrt{\sigma^n} \nabla \varphi_n\|^2.$$

The first term of the right-hand side clearly goes to 0 as $n \rightarrow \infty$. About the second term, we may notice that

$$\|\sqrt{\sigma^n} \nabla \varphi_n\|^2 \leq 2 \left(\|(\sqrt{\sigma^n} \nabla \varphi) \chi_n\|^2 + \|(\sqrt{\sigma^n} \nabla \chi_n) \varphi\|^2 \right)$$

and that

$$\nabla \chi_n = \phi_1'(\tilde{d}/\varepsilon_n) \frac{\nabla \tilde{d}}{\varepsilon_n}.$$

The conclusion immediately follows by (3.2) and (3.7). \square

Let u^i be an entire solution to the Helmholtz equation $\Delta u + k^2 u = 0$ in \mathbb{R}^N . We consider the scattering problem (2.2) with the configuration $\{K_1, K_2, K_3, s, \sigma, q, h, H\}$ replaced by $\{K_1^n, K_2^n, K_3^n, s^n, \sigma^n, q^n, h^n, H^n\}$ and we denote by u_n its solution.

We have the following theorem.

Theorem 3.2. *Under the previous assumptions, $v_n = u_n(1 - \chi_{H_n})$ converges to a function u strongly in $L^2(B_r)$ for any $r > 0$, with u solving*

$$\begin{cases} \Delta u + k^2 u = 0 & \text{in } \mathbb{R}^N \setminus K_0, \\ u = u^i + u^s & \text{in } \mathbb{R}^N \setminus K_0, \\ \nabla u \cdot \nu = 0 & \text{on } \partial K_0, \\ \lim_{r \rightarrow +\infty} r^{(N-1)/2} \left(\frac{\partial u^s}{\partial r} - i k u^s \right) = 0 & r = \|x\|, \end{cases} \quad (3.8)$$

and $u = 0$ in K_0 .

Proof. We develop the proof when Assumption 1 holds true. At suitable points of the proof, we shall describe the needed modification if Assumption 2 is used instead.

Let us begin by assuming the following further condition

$$\|v_n\|_{L^2(B_{R+1})} \leq C \quad \text{for any } n \in \mathbb{N}. \quad (3.9)$$

Let us assume that, up to a subsequence, we have that v_n converges weakly to u in $L^2(B_{R+1})$ as $n \rightarrow \infty$. We immediately infer that $u = 0$ in K_0 .

We notice that u_n satisfies the Helmholtz equation $\Delta u + k^2 u = 0$ in $\mathbb{R}^N \setminus \overline{B_R}$. By standard regularity estimates, we may infer that there exists a constant C_1 , depending on the constant C in (3.9) and R , such that for $R_1 = R + (1/2)$ we have

$$\|u_n\|_{C^0(\partial B_{R_1})} + \|\nabla u_n\|_{C^0(\partial B_{R_1})} \leq C_1 \quad \text{for any } n \in \mathbb{N}.$$

By the weak formulation of (2.2), we infer that

$$\begin{aligned} & \int_{B_{R_1} \setminus K^n} \sigma^n \nabla u_n \cdot \nabla \overline{u_n} = \\ & \int_{B_{R_1} \setminus K^n} k^2 q^n |u_n|^2 + \int_{\partial K_3^n} s^n |u_n|^2 + \int_{H_n \setminus K^n} h \overline{u_n} + \int_{H_n \setminus K^n} H \cdot \nabla \overline{u_n} + \int_{\partial B_{R_1}} (\nabla u_n \cdot \nu) \overline{u_n}, \end{aligned} \quad (3.10)$$

where we recall that $K^n = K_1^n \cup K_2^n \cup K_3^n$.

Clearly there exists a constant C_2 , depending on C_1 and R only, such that

$$\left| \int_{\partial B_{R_1}} (\nabla u_n \cdot \nu) \overline{u_n} \right| \leq C_2 \quad \text{for any } n \in \mathbb{N}.$$

We need that $\{(v_n, \sqrt{\sigma^n} \nabla v_n (1 - \chi_{J_n}))\}_{n \in \mathbb{N}}$ is uniformly bounded in $L^2(B_{R_1}, \mathbb{R}^{N+1})$, that is

$$\|(v_n, \sqrt{\sigma^n} \nabla v_n (1 - \chi_{J_n}))\|_{L^2(B_{R_1}, \mathbb{R}^{N+1})} \leq C_3 \quad \text{for any } n \in \mathbb{N}. \quad (3.11)$$

Notice that we are assuming as usual that $\sqrt{\sigma^n} \nabla v_n$ is extended to zero in H_n . If this is the case, up to a subsequence, $(v_n, \sqrt{\sigma^n} \nabla v_n (1 - \chi_{J_n}))$ converges weakly in $L^2(B_{R_1}, \mathbb{R}^{N+1})$ to (v, V) as $n \rightarrow \infty$. Clearly $v = u$, and, by property *i*) of Lemma 3.1, we have that $u \in H^1(B_{R_1} \setminus K_0)$ and $V = \nabla u$ in $B_{R_1} \setminus K_0$. Moreover, u and V are zero in K_0 .

Let us prove such a uniform boundedness. Here the proof is slightly different depending on the Assumption used. We begin with Assumption 1.

Obviously

$$0 \leq \int_{B_{R_1} \setminus K_n} k^2 q^n |u_n|^2 = k^2 \int_{B_{R_1} \setminus K_n} |u_n|^2 \leq k^2 C^2.$$

We split into the real and imaginary parts and, by the properties of q^n and s^n , we obtain that, inside K_n , $\int_{H_n \setminus K^n} q_2^n |u_n|^2$ and $\int_{K_n \setminus H_n} q_2^n |u_n|^2$ are not negative. Furthermore,

$$0 \leq \int_{H_n \setminus K^n} k^2 q_2^n |u_n|^2 + \int_{K_n \setminus H_n} k^2 q_2^n |u_n|^2 \leq \frac{E_3}{2} + \frac{1}{2} \int_{H_n \setminus K^n} k^2 q_2^n |u_n|^2 + \frac{E_3}{2c} + \frac{c}{2} \int_{H_n \setminus K^n} \sigma^n \nabla u_n \cdot \nabla \overline{u_n} + C_2,$$

for any positive constant c , which we shall fix later. Hence, we have that both integrals $\int_{H_n \setminus K^n} k^2 q_2^n |u_n|^2$ and $\int_{K_n \setminus H_n} k^2 q_2^n |u_n|^2$ are bounded by the following quantity

$$A_n = E_3 + \frac{E_3}{c} + c \int_{H_n \setminus K^n} \sigma^n \nabla u_n \cdot \nabla \overline{u_n} + 2C_2.$$

We conclude that

$$k^2 \int_{K_n \setminus H_n} |u_n|^2 \leq (A_n/E_1') \omega_1(\varepsilon_n) \quad \text{and} \quad k^2 \int_{H_n \setminus K^n} |u_n|^2 \leq A_n \left(\inf_{H_n \setminus K^n} q_2^\varepsilon \right)^{-1}. \quad (3.12)$$

Hence

$$\int_{K_n \setminus H_n} k^2 q_1^n |u_n|^2 \leq (E_1/E_1') A_n \quad \text{and} \quad \int_{H_n \setminus K^n} k^2 q_1^n |u_n|^2 \leq E_3 A_n.$$

We deduce that

$$\int_{B_{R_1} \setminus K^n} \sigma^n \nabla u_n \cdot \nabla \overline{u_n} \leq k^2 C^2 + (E_1/E_1') A_n + E_3 A_n + \frac{E_3}{2} + \frac{1}{2} A_n + \frac{E_3}{2c_1} + \frac{c_1}{2} \int_{H_n \setminus K^n} \sigma^n \nabla u_n \cdot \nabla \overline{u_n} + C_2$$

for any positive constant c_1 , that we shall fix later. Setting $\tilde{E} = (E_1/E_1') + E_3 + 1/2$ and $\tilde{C} = k^2 C^2 + E_3/2 + C_2$, we choose c and c_1 such that $\tilde{E}c + c_1/2 = 1/2$ and we obtain that

$$\int_{B_{R_1} \setminus K^n} \sigma^n \nabla u_n \cdot \nabla \overline{u_n} \leq 2\tilde{C} + 2\tilde{E}\tilde{E}_1 + E_3/c_1$$

where $\tilde{E}_1 = E_3 + E_3/c + 2C_2$.

We conclude that there exists a constant \tilde{C}_1 such that

$$\int_{B_{R_1} \setminus K^n} \sigma^n \nabla u_n \cdot \nabla \overline{u_n} \leq \tilde{C}_1 \quad \text{for any } n \in \mathbb{N}$$

thus in particular

$$\int_{B_{R_1} \setminus J_n} \sigma^n \nabla u_n \cdot \nabla \overline{u_n} \leq \tilde{C}_1 \quad \text{for any } n \in \mathbb{N} \quad (3.13)$$

and the required uniform boundedness property is achieved.

Moreover, we can also infer that there exists a constant A such that $A_n \leq A$ for any $n \in \mathbb{N}$ and that

$$k^2 \int_{K_n \setminus H_n} |u_n|^2 \leq (A/E'_1) \omega_1(\varepsilon_n) \quad \text{for any } n \in \mathbb{N}. \quad (3.14)$$

Finally, there exists a constant \tilde{C}_2 such that

$$\int_{B_{R_1} \setminus K^n} k^2 |q^n| |u_n|^2 \leq \tilde{C}_2 \quad \text{for any } n \in \mathbb{N}$$

and in particular such that

$$\int_{B_{R_1} \setminus H_n} k^2 |q^n| |u_n|^2 \leq \tilde{C}_2 \quad \text{for any } n \in \mathbb{N}. \quad (3.15)$$

For what concerns Assumption 2, the reasoning may be changed in the following way. We have that

$$0 \leq \int_{H_n \setminus K^n} k^2 q_2^n |u_n|^2 + \int_{K_n \setminus H_n} k^2 q_2^n |u_n|^2 \leq \frac{E_3}{2} + \frac{1}{2} \int_{H_n \setminus K^n} k^2 q_2^n |u_n|^2 + C_2.$$

Therefore, we obtain that

$$0 \leq \int_{K_n \setminus H_n} k^2 q_2^n |u_n|^2 \leq \frac{E_3}{2} + C_2 = A.$$

We easily conclude that (3.14) and (3.15) hold true also in this case.

Let us now define, for any $n \in \mathbb{N}$, $\chi_n = \phi_2(\tilde{d}/\varepsilon_n)$. We apply a Caccioppoli-type inequality. Namely, we have that

$$\int_{B_{R_1} \setminus H_n} \sigma^n \nabla u_n \cdot \nabla (\overline{u_n} \chi_n^2) = \int_{B_{R_1} \setminus H_n} k^2 q^n |u_n|^2 \chi_n^2 + \int_{\partial B_{R_1}} (\nabla u_n \cdot \nu) \overline{u_n}.$$

Therefore,

$$\begin{aligned} \int_{B_{R_1} \setminus H_n} \chi_n^2 \sigma^n \nabla u_n \cdot \nabla \overline{u_n} &\leq \tilde{C}_2 + C_2 + 2 \left| \int_{B_{R_1} \setminus H_n} \overline{u_n} \chi_n \sigma^n \nabla u_n \cdot \nabla \chi_n \right| \leq \\ &\tilde{C}_2 + C_2 + \frac{1}{2} \int_{B_{R_1} \setminus H_n} \chi_n^2 \sigma^n \nabla u_n \cdot \nabla \overline{u_n} + 2 \int_{B_{R_1} \setminus H_n} |u_n|^2 \sigma^n \nabla \chi_n \cdot \nabla \chi_n, \end{aligned}$$

that is

$$\int_{B_{R_1} \setminus H_n} \chi_n^2 \sigma^n \nabla u_n \cdot \nabla \overline{u_n} \leq 2\tilde{C}_2 + 2C_2 + \frac{4}{\varepsilon_n^2} \int_{K_n \setminus H_n} |u_n|^2 (\phi_2'(\tilde{d}/\varepsilon_n))^2 \sigma^n \nabla \tilde{d} \cdot \nabla \tilde{d}.$$

By (3.3), we conclude that (3.13) also holds true.

Let us fix $\varphi \in H^1(B_{R+1} \setminus K_0)$ whose support is contained in B_{R_1} and such that φ is bounded. By property *ii*) of Lemma 3.1, we can construct for any $n \in \mathbb{N}$ a function $\varphi_n \in H^1(B_{R+1})$, whose support is contained in B_{R_1} and such that $\varphi_n = 0$ in J_n , with $(\varphi_n, \sqrt{\sigma^n} \nabla \varphi_n)$ converging strongly to $(\varphi, \nabla \varphi)$ in $L^2(B_{R+1}, \mathbb{R}^{N+1})$ as $n \rightarrow \infty$, where φ and $\nabla \varphi$ are extended to 0 in K_0 .

We have that

$$\int_{B_{R_1}} \sigma^n \nabla v_n \cdot \nabla \varphi_n - \int_{B_{R_1}} k^2 q^n v_n \varphi_n = 0.$$

It is easy to show that

$$\lim_{n \rightarrow \infty} \int_{B_{R_1}} \sigma^n \nabla v_n \cdot \nabla \varphi_n = \int_{B_{R+1} \setminus K_0} \nabla u \cdot \nabla \varphi.$$

We observe that

$$\begin{aligned} \int_{B_{R_1}} k^2 q^n v_n \varphi_n &= \int_{B_{R+1} \setminus K_n} k^2 v_n \varphi_n + \int_{K_n \setminus H_n} k^2 q^n u_n \varphi_n = \\ &= \int_{B_{R+1}} k^2 v_n \varphi \chi_{B_{R+1} \setminus K_n} + \int_{K_n \setminus H_n} k^2 q^n u_n \varphi_n. \end{aligned}$$

Obviously

$$\lim_{n \rightarrow \infty} \int_{B_{R+1}} v_n \varphi \chi_{B_{R+1} \setminus K_n} = \int_{B_{R+1} \setminus K_0} u \varphi.$$

Finally, since φ_n is uniformly bounded and $\int_{K_n \setminus H_n} k^2 |q^n| |u_n|^2$ is uniformly bounded, and by (3.4), we are able to pass to the limit and prove that

$$\int_{B_{R+1} \setminus K_0} \nabla u \cdot \nabla \varphi - k^2 u \varphi = 0.$$

By density, we have this last equation holds for any $\varphi \in H^1(B_{R+1} \setminus K_0)$ whose support is compactly contained in B_{R_1} .

By Lemma 3.1 in [37], we have that, up to a subsequence, u_n converges to a function u uniformly on compact subsets of $\mathbb{R}^N \setminus \overline{B_R}$, with u solving

$$\begin{cases} \Delta u + k^2 u = 0 & \text{in } \mathbb{R}^N \setminus \overline{B_R} \\ u = u^i + u^s & \text{in } \mathbb{R}^N \setminus \overline{B_R} \\ \lim_{r \rightarrow +\infty} r^{(N-1)/2} \left(\frac{\partial u^s}{\partial r} - i k u^s \right) = 0 & r = \|x\|. \end{cases}$$

Then we immediately conclude that u is the unique solution to (3.8). We now show that the whole sequence v_n converges to u strongly in $L^2(B_r)$ for any $r > 0$. By uniqueness of the solution to (3.8), we have that the whole sequence v_n converges to u weakly in $L^2(B_{R+1/2})$ and uniformly on compact subsets of $\mathbb{R}^N \setminus \overline{B_R}$. Moreover, by standard regularity estimates, we may also assume that v_n converges to u strongly in L^2 on any compact subset of $B_{R+1} \setminus K_0$.

We recall that there exist constants $p > 2$ and $C_4 > 0$ such that for any $n \in \mathbb{N}$ we have

$$\|u\|_{L^p(B_{R_1} \setminus K_n)} \leq C_4 \|u\|_{H^1(B_{R_1} \setminus K_n)} \quad \text{for any } u \in H^1(B_{R_1} \setminus K_n). \quad (3.16)$$

Let us fix a positive constant h_0 , $0 < h_0 \leq \min\{\varepsilon_0, 1/4\}$. For any h , $0 < h \leq h_0$, let $A_h = K_h \cup (B_{R_1} \setminus \overline{B_{R_1-h}})$ and $B_h = B_{R_1} \setminus A_h$. We notice that B_h is compactly contained in $B_{R_1} \setminus K_0$ and that $\lim_{h \rightarrow 0^+} |A_h \setminus K_0| = 0$.

Therefore, for any h , $0 < h \leq h_0$, there exists $\bar{n} \in \mathbb{N}$ such that for any $n \geq \bar{n}$ we have $\varepsilon_n \leq h$ and

$$\|v_n - u\|_{L^2(B_{R_1})} \leq \|u\|_{L^2(A_h \setminus K_0)} + \|u_n\|_{L^2(K_n \setminus H_n)} + \|u_n\|_{L^2(A_h \setminus K_n)} + \|u_n - u\|_{L^2(B_h)}.$$

By (3.16) and (3.11), we infer that

$$\|v_n - u\|_{L^2(B_{R_1})} \leq \|u\|_{L^2(A_h \setminus K_0)} + \|u_n\|_{L^2(K_n \setminus H_n)} + C_3 C_4 |A_h \setminus K_n|^{(p-2)/(2p)} + \|u_n - u\|_{L^2(B_h)}.$$

By (3.14), we conclude that for any $n \geq \bar{n}$

$$\|v_n - u\|_{L^2(A_h)} \leq \|u\|_{L^2(A_h \setminus K_0)} + \sqrt{(A/(k^2 E'_1))\omega_1(\varepsilon_n)} + C_3 C_4 |A_h \setminus K_0|^{(p-2)/(2p)}.$$

We fix $\delta > 0$. There exist \bar{h} , $0 < \bar{h} \leq h_0$, and $\bar{n} \in \mathbb{N}$ such that for any $n \geq \bar{n}$ we have $\varepsilon_n \leq \bar{h}$ and

$$\|v_n - u\|_{L^2(A_{\bar{n}})} \leq \delta/2.$$

There exists $\tilde{n} \geq \bar{n}$ such that for any $n \geq \tilde{n}$ we have

$$\|u_n - u\|_{L^2(B_{\tilde{n}})} \leq \delta/2,$$

therefore we have proved that v_n converges to u strongly in $L^2(B_{R_1})$ and consequently strongly in $L^2(B_r)$ for any $r > 0$.

In order to conclude the proof, we have to show that (3.9) holds true. Let $a_n = \|v_n\|_{L^2(B_{R+1})}$. By contradiction, let us assume that $\lim_{n \rightarrow \infty} a_n = +\infty$, possibly by passing to a subsequence. Let us consider $w_n = u_n/a_n$. We have that

$$\|w_n(1 - \chi_{H_n})\|_{L^2(B_{R+1})} = 1.$$

Therefore $w_n(1 - \chi_{H_n})$ converges to a function w strongly in L^2 on any compact subset of \mathbb{R}^N . The function w satisfies

$$\begin{cases} \Delta w + k^2 w = 0 & \text{in } \mathbb{R}^N \setminus K_0 \\ \nabla w \cdot \nu = 0 & \text{on } \partial K_0. \end{cases} \quad (3.17)$$

Clearly we also have that $\|w\|_{L^2(B_{R+1})} = 1$.

We have that $\|u_n^s/a_n\|_{L^2(B_{R+1} \setminus \overline{B_R})}$, $n \in \mathbb{N}$, is uniformly bounded. Therefore, again up to a subsequence, u_n^s/a_n converges, as $n \rightarrow \infty$, to a function \tilde{w} strongly in L^2 on any compact subset of $\mathbb{R}^N \setminus \overline{B_R}$. Such a function \tilde{w} satisfies

$$\begin{cases} \Delta \tilde{w} + k^2 \tilde{w} = 0 & \text{in } \mathbb{R}^N \setminus \overline{B_R} \\ \lim_{r \rightarrow +\infty} r^{(N-1)/2} \left(\frac{\partial \tilde{w}}{\partial r} - ik\tilde{w} \right) = 0 & r = \|x\|. \end{cases} \quad (3.18)$$

Since $w_n = u^i/a_n + u_n^s/a_n$, we may immediately conclude that, outside $\overline{B_R}$, we have $w = \tilde{w}$. That is w solves

$$\begin{cases} \Delta w + k^2 w = 0 & \text{in } \mathbb{R}^N \setminus K_0 \\ \nabla w \cdot \nu = 0 & \text{on } \partial K_0 \\ \lim_{r \rightarrow +\infty} r^{(N-1)/2} \left(\frac{\partial w}{\partial r} - ikw \right) = 0 & r = \|x\|. \end{cases} \quad (3.19)$$

By uniqueness, and since $\mathbb{R}^N \setminus K_0$ is connected, we may conclude that w is identically zero, which leads to a contradiction since $\|w\|_{L^2(B_{R+1})}$ should be equal to 1. \square

We summarize the results of this section in the following theorem.

Theorem 3.3. *Under the previous assumptions, for any ε , $0 < \varepsilon \leq \varepsilon_0$, let us fix $\sigma_l^\varepsilon = \sigma_l^\varepsilon(x)$, $x \in K_\varepsilon \setminus K_{\varepsilon/2}$, an $N \times N$ symmetric matrix whose entries are real-valued measurable functions such that, for some λ_ε , $0 < \lambda_\varepsilon \leq 1$, we have*

$$\lambda_\varepsilon \|\xi\|^2 \leq \hat{\sigma}^\varepsilon(x) \xi \cdot \xi \quad \text{for any } \xi \in \mathbb{R}^N \text{ and for a.e. } x \in K_\varepsilon \setminus K_{\varepsilon/2}.$$

Let $q_l^\varepsilon = \hat{q}_1^\varepsilon + i\hat{q}_2^\varepsilon = q_l^\varepsilon(x)$, $x \in K_\varepsilon \setminus K_{\varepsilon/2}$, be a complex-valued bounded measurable function, with real and imaginary parts \hat{q}_1^ε and \hat{q}_2^ε respectively, such that, for some λ_ε , $0 < \lambda_\varepsilon \leq 1$, we have

$$\hat{q}_1^\varepsilon(x) \geq \lambda_\varepsilon \quad \text{and} \quad \hat{q}_2^\varepsilon(x) \geq 0 \quad \text{for a.e. } x \in K_\varepsilon \setminus K_{\varepsilon/2}.$$

We further require that σ_l^ε and q_l^ε satisfy Assumption 1b), for a given function ω_1 and given constants E_1, E'_1, Λ , and E_2 .

Then let $\{K_1^\varepsilon, K_2^\varepsilon, K_3^\varepsilon, s^\varepsilon, \sigma^\varepsilon, q^\varepsilon, h^\varepsilon, H^\varepsilon\}$ be any admissible configuration such that

$$\sigma^\varepsilon = \sigma_l^\varepsilon \quad \text{and} \quad q^\varepsilon = q_l^\varepsilon \quad \text{in } K_\varepsilon \setminus K_{\varepsilon/2}$$

and satisfies, for a given constant E_3 , either Assumption 1 or Assumption 2. Notice that if Assumption 1 is used, we may replace (3.3) with (3.7).

For any $d \in \mathbb{S}^{N-1}$, let $u^i(x) = e^{ikx \cdot d}$, $x \in \mathbb{R}^N$. Let u_ε be the solution to (2.2) with the configuration $\{K_1, K_2, K_3, s, \sigma, q, h, H\}$ replaced by $\{K_1^\varepsilon, K_2^\varepsilon, K_3^\varepsilon, s^\varepsilon, \sigma^\varepsilon, q^\varepsilon, h^\varepsilon, H^\varepsilon\}$, and u be the solution to (3.8). Let u_∞^ε and u_∞ be the scattering amplitudes of the corresponding scattered waves, respectively.

Then there exists a function $\omega : (0, \varepsilon_0] \rightarrow (0, +\infty]$ such that $\lim_{s \rightarrow 0^+} \omega(s) = 0$, depending on $K_0, \tilde{d}, R, \sigma_l^\varepsilon, q_l^\varepsilon$, and E_3 only, and a constant C depending on R only, such that for any ε , $0 < \varepsilon \leq \varepsilon_0$, we have

$$\|u^\varepsilon - u\|_{L^2(B_{R+1} \setminus \overline{B_R})} \leq \omega(\varepsilon) \quad (3.20)$$

and

$$\|u_\infty^\varepsilon - u_\infty\|_{L^\infty(\mathbb{S}^{N-1})} \leq C\omega(\varepsilon). \quad (3.21)$$

4 Full and partial cloaks in the physical space

In this section, we shall apply Theorem 3.3 to the constructions of full and partial invisibility cloaks in the physical space. We shall stick to the terminologies introduced in Section 2 for the general construction of the cloaks. Specifically, we shall let $\{K_1^\varepsilon, K_2^\varepsilon, K_3^\varepsilon, s^\varepsilon, \sigma^\varepsilon, q^\varepsilon, h^\varepsilon, H^\varepsilon\}$ and $\{\Sigma_1, \Sigma_2, \Sigma_3, s, \tilde{\sigma}^\varepsilon, \tilde{q}^\varepsilon, h, H\}$ be the scattering objects respectively in the virtual and physical spaces. Let F_ε be the blow-up transformation from the virtual space to the physical space.

4.1 Regularized full invisibility cloak

Suppose D is the closure of a bounded convex domain in \mathbb{R}^N that contains the origin. Let Ω be the closure of a bounded Lipschitz domain in \mathbb{R}^N such that $D \subset \overset{\circ}{\Omega}$ and $\Omega \setminus D$ is connected.

For any $\varepsilon > 0$, let $D_\varepsilon = \{\varepsilon x; x \in D\}$. It is supposed that for any $0 < \varepsilon < 1$ there exists a (uniformly) bi-Lipschitz and orientation-preserving map,

$$F_\varepsilon^{(1)} : \Omega \setminus D_\varepsilon \rightarrow \Omega \setminus D, \quad F_\varepsilon^{(1)}|_{\partial\Omega} = \text{Identity}. \quad (4.1)$$

That is, $F_\varepsilon^{(1)}$ blows up D_ε to D within Ω . Let

$$F_\varepsilon^{(2)}(x) = \frac{x}{\varepsilon}, \quad x \in D_\varepsilon, \quad (4.2)$$

and

$$F_\varepsilon = \begin{cases} \text{Identity} & \text{on } \mathbb{R}^N \setminus \Omega, \\ F_\varepsilon^{(1)} & \text{on } \Omega \setminus D_\varepsilon, \\ F_\varepsilon^{(2)} & \text{on } D_\varepsilon. \end{cases} \quad (4.3)$$

Formally, we set

$$\Sigma = D_{1/2}, \quad K_\varepsilon = D_\varepsilon, \quad K_{\varepsilon/2} = D_{\varepsilon/2}. \quad (4.4)$$

Furthermore, we set

$$\tilde{\sigma}_c^\varepsilon = (F_\varepsilon^{(1)})_* I, \quad \tilde{q}_c^\varepsilon = (F_\varepsilon^{(1)})_* 1 \quad \text{in } \Omega \setminus D, \quad (4.5)$$

and

$$(D \setminus D_{1/2}; \tilde{\sigma}_l^\varepsilon, \tilde{q}_l^\varepsilon) = (F_\varepsilon)_*(K_\varepsilon \setminus K_{\varepsilon/2}; \sigma_l^\varepsilon, q_l^\varepsilon), \quad (4.6)$$

with

$$\sigma_l^\varepsilon = c_1(x)\varepsilon^2, \quad q_l^\varepsilon = (c_2(x) + ic_3(x))\varepsilon^{-N+1}. \quad (4.7)$$

In (4.7), $c_1(x)$ is a symmetric-matrix valued measurable function, and $c_2(x), c_3(x)$ are bounded real valued measurable function such that

$$\lambda_0 \|\xi\|^2 \leq c_1(x)\xi \cdot \xi \leq \Lambda_0 \|\xi\|^2, \quad \lambda_0 \leq c_2(x), c_3(x) \leq \Lambda_0 \quad \text{for a.e. } x \in K_\varepsilon \setminus K_{\varepsilon/2}, \quad (4.8)$$

where λ_0 and Λ_0 are two positive constants independent of ε . $(D \setminus D_{1/2}; \tilde{\sigma}_l^\varepsilon, \tilde{q}_l^\varepsilon)$ is the chosen lossy layer for our cloaking scheme. By Lemma 2.1, it is straightforward to verify that

$$\tilde{\sigma}_l^\varepsilon(x) = c_1(\varepsilon x)\varepsilon^N, \quad \tilde{q}_l^\varepsilon(x) = (c_2(\varepsilon x) + ic_3(\varepsilon x))\varepsilon, \quad x \in D \setminus D_{1/2}. \quad (4.9)$$

We would like to emphasize that (4.9) is only a particular choice for illustration of our general results in Section 3, and there are more choices as long as $(K_\varepsilon \setminus K_{\varepsilon/2}; \sigma_l^\varepsilon, q_l^\varepsilon)$ is such chosen that Assumption 1, b) is satisfied.

Next, we first consider the cloaking of passive objects by assuming $-h + \operatorname{div}(H) = 0$ in the physical space. Let $(\Sigma_1, \Sigma_2, \Sigma_3, s)$ be an admissible obstacle located inside $D_{1/2}$, and $(D_{1/2} \setminus \bigcup_{l=1}^3 \Sigma_l; \tilde{\sigma}_a, \tilde{q}_a)$ be an arbitrary regular medium. Let $(K_\varepsilon^1, K_\varepsilon^2, K_\varepsilon^3, s^\varepsilon)$ and $(K_{\varepsilon/2}; \sigma_a^\varepsilon, q_a^\varepsilon)$ be the corresponding virtual images in the virtual space. Also, we set $K^\varepsilon = \bigcup_{l=1}^3 K_l^\varepsilon$. Hence, in the physical space

$$(\mathbb{R}^N; \tilde{\sigma}^\varepsilon, \tilde{q}^\varepsilon) = \begin{cases} I, 1 & \text{in } \mathbb{R}^N \setminus \Omega, \\ \tilde{\sigma}_c^\varepsilon, \tilde{q}_c^\varepsilon & \text{in } \Omega \setminus D, \\ \tilde{\sigma}_l^\varepsilon, \tilde{q}_l^\varepsilon & \text{in } D \setminus D_{1/2}, \\ \tilde{\sigma}_a, \tilde{q}_a & \text{in } D_{1/2}, \end{cases} \quad (4.10)$$

Proposition 4.1. *Let $\{\Sigma_1, \Sigma_2, \Sigma_3, s, \tilde{\sigma}^\varepsilon, \tilde{q}^\varepsilon\}$ and $\{K_\varepsilon^1, K_\varepsilon^2, K_\varepsilon^3, s^\varepsilon, \sigma^\varepsilon, q^\varepsilon\}$ be as described above, and \tilde{u}_ε and u_ε be the corresponding scattering waves (cf. (2.12) and (2.14)). We also let $\tilde{u}_\infty^\varepsilon$ and u_∞^ε be the scattering amplitudes of, respectively, \tilde{u}_ε and u_ε .*

Then there exist $\varepsilon_0 > 0$ and a function $\omega : (0, \varepsilon_0] \rightarrow (0, +\infty]$ with $\lim_{s \rightarrow 0^+} \omega(s) = 0$, which is independent of $\tilde{\sigma}_a, \tilde{q}_a$ and $\Sigma_1, \Sigma_2, \Sigma_3, s$, and of the impinging direction d , such that for any $\varepsilon < \varepsilon_0$

$$\|\tilde{u}_\infty^\varepsilon\|_{L^\infty(\mathbb{S}^{N-1})} = \|u_\infty^\varepsilon\|_{L^\infty(\mathbb{S}^{N-1})} \leq \omega(\varepsilon). \quad (4.11)$$

Proof. Let O be the origin. For any $x \in \mathbb{R}^N$, let $\tilde{x} \in \partial D$ be the point lying on the line passing through O and x . Set

$$\tilde{d}(x) = \operatorname{dist}(\tilde{x}, O)^{-1}d(x) \quad \text{for any } x \in \mathbb{R}^N.$$

By taking $K_0 := \{O\}$, it is easily seen that $K_\varepsilon = D_\varepsilon$ and $K_{\varepsilon/2} = D_{\varepsilon/2}$. Since K_0 has zero capacity, we know that the solution to (3.8) is given by $u = u^i$. Consequently, $u^s = 0$ and $u_\infty = 0$. One readily has (4.11) by Theorem 3.3. \square

Proposition 4.1 indicates that one would have an approximate full invisibility cloak for the construction (4.1)–(4.10). The essential point in Proposition 4.1 is that a single point has zero capacity. We recall that $H^1(D) = H^1(D \setminus K_0)$ for any open set D and any compact $K_0 \subset D$ with zero capacity. We would like to emphasize that by following the same spirit, and using Theorem 3.3, one could have more approximate full invisibility cloaks. For example, in \mathbb{R}^3 , a line segment is also of zero capacity, and hence one could achieve an approximate full cloak by blowing up a ‘line-segment-like’ region in \mathbb{R}^3 ,

namely K_0 is a line segment; or by blowing up a finite collection of ‘point-like’ and ‘line-segment-like’ regions. In Section 5, we shall give more discussion on how to construct an approximate full cloak by blowing up a ‘line-segment-like’ region.

Finally, we consider the cloaking of active contents.

Proposition 4.2. *Under the same assumptions of Proposition 4.1, we further assume that the source/sink term satisfies the following. We let $H = 0$ and $h \in L^2(\mathbb{R}^N \setminus \Sigma)$ be such that $\text{supp}(h) \subset D_{1/2} \setminus \Sigma$. Moreover, we require that*

$$\Im \tilde{q}_a \geq \lambda_0 > 0 \quad \text{on } \text{supp}(h), \quad (4.12)$$

where λ_0 is a constant.

Then there exist $\varepsilon_0 > 0$ and a function $\omega : (0, \varepsilon_0] \rightarrow (0, +\infty]$ with $\lim_{s \rightarrow 0^+} \omega(s) = 0$, which is independent of $\tilde{\sigma}_a, \Re \tilde{q}_a, \Im \tilde{q}_a|_{\{h=0\}}$ and $\Sigma_1, \Sigma_2, \Sigma_3, s$, and of the impinging direction d , such that for any $\varepsilon < \varepsilon_0$

$$\|\tilde{u}_\infty^\varepsilon\|_{L^\infty(\mathbb{S}^{N-1})} = \|u_\infty^\varepsilon\|_{L^\infty(\mathbb{S}^{N-1})} \leq \omega(\varepsilon). \quad (4.13)$$

Proof. It is straightforward to verify that

$$\int_{K_{\varepsilon/2} \setminus K^\varepsilon} (k^2 \Im \tilde{q}_a^\varepsilon)^{-1} |h^\varepsilon|^2 = \int_{\text{supp}(h)} (k^2 \Im \tilde{q}_a)^{-1} |h|^2 \leq k^{-2} \lambda_0^{-1} \int_{D_{1/2} \setminus \Sigma} |h|^2 := E_3 < +\infty. \quad (4.14)$$

Hence, Assumption 2, c) is satisfied. The proposition can be proved following a completely similar argument as that for Proposition 4.1 by using Theorem 3.3. \square

Remark 4.1. Proposition 4.2 indicates that in addition to passive mediums, the construction (4.1)–(4.10) is also capable of nearly cloaking active contents. We need that at the place where the active source is located, the medium must be absorbing. It is recalled that the Helmholtz equation can also be used to describe the electromagnetic phenomena. In such a case, h denotes an electric current density, whereas $\Im \tilde{q}_a$ denotes the conductivity. At the place where $\Im \tilde{q}_a = 0$, one must have $h = 0$ since there the medium is non-conducting. Hence, (4.14) is a reasonable physical condition. Moreover, we would like to emphasize that one can nearly cloak a more general source term of the form $-h + \text{div}(H)$ by using Assumption 1, c) by imposing certain physical conditions on $\tilde{\sigma}_a$ and \tilde{q}_a .

4.2 Regularized partial invisibility cloak

Our construction of partial cloaking devices will rely on blowing up ‘partially’ small regions in the virtual space. We first present our study in the virtual space. Let

$$K_0 := \{-a \leq x_1 \leq a\} \times \{x_2 = 0\} \quad \text{in } \mathbb{R}^2, \quad (4.15)$$

and

$$K_0 := \{-a \leq x_1 \leq a\} \times \{-b \leq x_2 \leq b\} \times \{x_3 = 0\} \quad \text{in } \mathbb{R}^3. \quad (4.16)$$

We note that $\nu = (0, 1)$ in 2D and $\nu = (0, 0, 1)$ in 3D for K_0 . Let $0 \leq \tau \leq 1$ and define

$$\mathcal{N}_\tau := \{\theta \in \mathbb{S}^{N-1} : |\nu \cdot \theta| \leq \tau\}. \quad (4.17)$$

Next, we consider the scattering problem (3.8) with K_0 given in (4.15) and (4.16), which is known as the *screen problem* in the literature.

Proposition 4.3. *Let K_0 be given in (4.15) and (4.16), and \mathcal{N}_τ be given in (4.17). Let $u \in H_{loc}^1(\mathbb{R}^N \setminus K_0)$ be the solution to (3.8) with $u^i(x) = e^{ikx \cdot d}$. Then there exists a constant C , depending only on a, b and k , such that*

$$|u_\infty(\hat{x}, d)| \leq C\tau \quad \text{for } \hat{x} \in \mathbb{S}^{N-1} \text{ and } d \in \mathcal{N}_\tau, \quad (4.18)$$

and

$$|u_\infty(\hat{x}, d)| \leq C\tau \quad \text{for } \hat{x} \in \mathcal{N}_\tau \text{ and } d \in \mathbb{S}_{N-1}. \quad (4.19)$$

Proof. By the well-posedness of the forward scattering problem, we know

$$\|u_\infty(\cdot, d)\|_{L^\infty(\mathbb{S}^{N-1})} \leq C \left\| \frac{\partial u^i}{\partial \nu} \right\|_{L^2(K_0)} = Ck|\nu \cdot d|(\mathcal{H}^{N-1}(K_0))^{1/2}, \quad (4.20)$$

from which one readily has (4.18) by recalling the definition of \mathcal{N}_τ . (4.19) can be obtained from (4.18) by using the following reciprocity relation (see, e.g., [9])

$$u_\infty(-d, -\hat{x}) = u_\infty(\hat{x}, d) \quad \text{for } \hat{x} \in \mathbb{S}^{N-1} \text{ and } d \in \mathbb{S}^{N-1}. \quad (4.21)$$

The proof is completed. \square

Now, the construction of a partial cloak shall be based on the use of Theorem 3.3 and Proposition 4.3, similar to the one for the full cloaks in Section 4.1 by following the next three steps. First, one chooses K_ε , an ε -neighborhood of K_0 , and a blow-up transformation F_ε , and through the push-forwards, one constructs the cloaking layer $(\Omega \setminus D; \tilde{\sigma}_c^\varepsilon, \tilde{q}_c^\varepsilon)$. Second, according to Assumption 1, b), a compatible lossy layer $(K_\varepsilon \setminus K_{\varepsilon/2}; \sigma_l^\varepsilon, q_l^\varepsilon)$ is chosen in the virtual space, and then by the push-forwards, one would have the corresponding lossy layer in the physical space. Finally, according to Assumption 1 or 2, c), one can determine the admissible media, obstacles, or sources that can be partially cloaked. Next, let us consider a simple 2D example by letting $K_\varepsilon = [-1-\varepsilon, 1+\varepsilon] \times [-\varepsilon, \varepsilon]$, which is an ε -neighborhood of $K_0 = [-1, 1] \times \{0\}$. If a uniformly blow-up as the one in (4.2) is used, then K_ε will be transformed into $[-1/\varepsilon-1, 1/\varepsilon+1] \times [-1, 1]$. In such a way, one would have a partial cloaking device of a very large size depending on ε^{-1} . For practical considerations, in the next section, we shall develop an assembled-by-components technique on blowing up a partially small region in constructing a regularized partial cloak of compact size.

5 ABC geometry and concatenated construction of three specific cloaks

In this section, we shall first discuss the assembled-by-components (ABC) geometry in the virtual and physical spaces, and then give the blow-up construction of three specific cloaks based on concatenating individual components. We would like to emphasize that we would not appeal for a most general study in this aspect, and instead we shall present our study based on these three specific examples. However, the technique developed could be straightforwardly extended to devising many other cloaks.

5.1 ABC geometry in the virtual and physical spaces

Define for $x = (x_1, \dots, x_N) \in \mathbb{R}^N$,

$$|x|_{w,\infty} := \max_l \{|w_l x_l|\}_{l=1}^N, \quad (5.1)$$

and for $1 \leq p < +\infty$,

$$|x|_{w,p} := \left(\sum_{l=1}^N |w_l x_l|^p \right)^{1/p}, \quad (5.2)$$

where $w = (w_1, \dots, w_N) \in \mathbb{R}^N$ with $0 < w_l \leq 1$ denotes a weight. For any $r > 0$ we define the (w, l^p) -ball and sphere, respectively, as follows

$$\Omega_{w,r}^{(p)} := \{x \in \mathbb{R}^N : |x|_{w,p} < r\} \quad \text{and} \quad S_{w,r}^{(p)} := \partial\Omega_{w,r}^{(p)}, \quad 1 \leq p \leq \infty. \quad (5.3)$$

Two semi- (w, l^p) -balls can be defined by

$$\Omega_{w,r,k}^{(p),+} := \{x \in \Omega_{w,r}^{(p)} : x_k > 0\} \quad \text{and} \quad \Omega_{w,r,k}^{(p),-} := \{x \in \Omega_{w,r}^{(p)} : x_k < 0\}.$$

$\Omega_{w,r}^{(p)}$ with $p = 1, 2, \infty$ will be the three *base geometries* for our subsequent constructions. Next, we show that by concatenating the base geometries, one could obtain more practical geometries in both the virtual and physical spaces.

In the sequel, we denote $x^{\check{k}} := (x_1, \dots, x_{k-1}, x_{k+1}, \dots, x_N) \in \mathbb{R}^{N-1}$ where the superscript \check{k} indicates that the k -th component x_k is dropped. Thus $N - 1$ dimensional $(w^{\check{k}}, l^p)$ -balls and semi-balls can be defined, respectively, by

$$\Omega_{w^{\check{k}},r}^{(p)} := \{|x^{\check{k}}|_{w^{\check{k}},p} < r\} \quad \text{and} \quad \Omega_{w^{\check{k}},r,j}^{(p),\pm} := \{x^{\check{k}} \in \Omega_{w^{\check{k}},r}^{(p)} : x_j \gtrless 0\},$$

where j is different from k .

5.1.1 2D ABC example C

We start with a simple 2D example. Let $w_0 := [1, 1]$ and

$$\mathbf{C}_L = \Omega_{w_0,r,1}^{(p),-} + [-a, 0], \quad \mathbf{C}_R = \Omega_{w_0,r,1}^{(p),+} + [a, 0] \quad (5.4)$$

and

$$\mathbf{C}_M = \{-a \leq x_1 \leq a\} \times \{-r \leq x_2 \leq r\}, \quad (5.5)$$

where r and a are positive constants, that we shall specify in the following. By assembling the three components, we obtain

$$\mathbf{C}_{[w_0, r, a]} = \mathbf{C}_L \cup \mathbf{C}_M \cup \mathbf{C}_R. \quad (5.6)$$

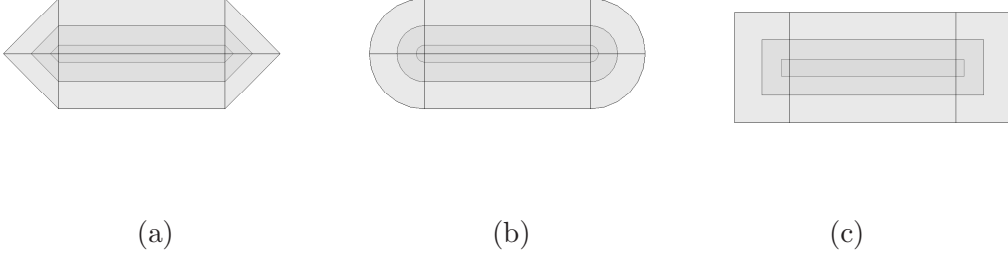

Figure 1: Two dimensional ABC geometry \mathbf{C} depicted in both the virtual space (between innermost and outermost boundaries) and the physical space (between intermediate and outermost boundaries). From left to right: l^1 , l^2 and l^∞ cloaks, respectively.

If one takes $p = p' = 2$, then $\mathbf{C}_{[w_0, r, a]}$ is a 2D *capsule*; if one takes $p = \infty$ and $p' = 1$, then $\mathbf{C}_{[w_0, r, a]}$ gives a 2D *nail*; and if $p = p' = \infty$, then $\mathbf{C}_{[w_0, r, a]}$ is a *rectangle*; see Figure 1 for these three constructions. In our subsequent construction of the partial cloaking device, we would take $\mathbf{C}_{[w_0, \varepsilon, a]}$ as the ‘partially’ small region in the virtual space, whereas $\mathbf{C}_{[w_0, r_2, a]} \setminus \mathbf{C}_{[w_0, r_1, a]}$ is the cloaking region in the physical space. Here $r_2 > r_1 > \varepsilon$ with $r_l \sim 1$, $l = 1, 2$ and a is a free parameter ranges from ε to 1 that determines the apertures of the cloaking device. It can be easily seen that if $a = 1$, then $\mathbf{C}_{[w_0, \varepsilon, 1]}$ is ‘partially’ small since it is only small in one dimension and of regular size in another dimension, whereas if $a = \varepsilon$ then it is uniformly small since, along both the x_1 - and x_2 -dimensions, the region is small.

5.1.2 3D ABC example D

We next consider a 3D example. Let $w_0 := [1, 1, 1]$ and define three detached components

$$\mathbf{D}_L = \Omega_{w_0, r, 1}^{(p), -} + [-a, 0, 0], \quad \mathbf{D}_R = \Omega_{w_0, r, 1}^{(p), +} + [a, 0, 0] \quad (5.7)$$

and

$$\mathbf{D}_M = \{-a \leq x_1 \leq a\} \times \{x^{\mathbf{i}} \in \overline{\Omega_{w^{\mathbf{i}}, r}^{(p)}}\}, \quad (5.8)$$

where r and a are positive constants, that we shall specify in the following. By assembling the three components as shown in Figure 2, we obtain the *slender cloak*

$$\mathbf{D}_{[w, r, a]} = \mathbf{D}_L \cup \mathbf{D}_M \cup \mathbf{D}_R. \quad (5.9)$$

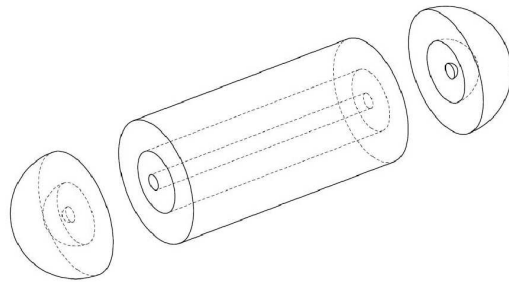

(a) Detached components in Type **D** cloak.

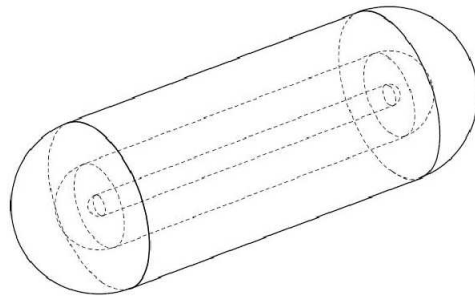

(b) Slender cloak with assembled components.

Figure 2: Schematic illustration for the construction of Type **D** cloaks.

For more concrete examples of this slender cloak construction, let $w_0 = [1, 1, 1]$, $a = 1$. We take $r = \varepsilon$ and $r = 1$, respectively, to represent the geometries in the virtual and physical spaces. If $p = p' = 2$, then $\mathbf{D}_{[w_0, r, 1]}$ is a 3D *capsule*; if $p = \infty$ and $p' = 1$, then $\mathbf{D}_{[w_0, r, 1]}$ is a 3D *nail*; and if $p = p' = \infty$, then $\mathbf{D}_{[w_0, r, 1]}$ is a *rectangular-prism*; see Figure 3 for illustration. In our subsequent discussion, $\mathbf{D}_{[w_0, \varepsilon, 1]}$ will be the region in the virtual space whereas $\mathbf{D}_{[w_0, 1, 1]}$ will be the region in the physical space. As can be easily seen, in the virtual space, $\mathbf{D}_{[w_0, 1, \varepsilon]}$ is small along the x_2 -, x_3 -dimensions while it is large along the x_1 -dimension. For our subsequent study, we are also interested in the case when the region in the virtual space is only small in the x_3 -dimension while it is large in the x_1 -, x_2 -dimensions. It is directly verified that $\mathbf{D}_{[w_\varepsilon, 1, \varepsilon]}$ with $w_\varepsilon = [1, \varepsilon, 1]$ satisfies such requirement. However, it can also be verified that for such w_ε , in the physical space $\mathbf{D}_{[w_\varepsilon, 1, 1]}$ is very large along the x_2 -dimension, which is actually of size $1/\varepsilon$. In order to construct a more practical partial cloaking device with its size independent of the regularization parameter ε , we would like to further develop the ABC geometry in the following. It is emphasized again that this is our major motivation in developing the ABC geometry.

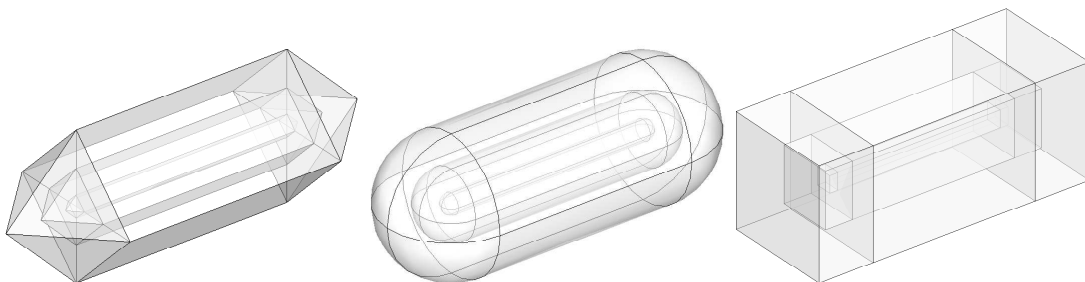

Figure 3: Three dimensional ABC geometry \mathbf{D} depicted in both the virtual space (between innermost and outermost boundaries) and the physical space (between intermediate and outermost boundaries). From left to right: l^1 , l^2 and l^∞ cloaks, respectively.

5.1.3 3D ABC example E

We next consider a specific example for further developing the ABC geometry (see Figure 4). Let

$$\mathbf{E}_0 = \{-a \leq x_1 \leq a\} \times \{-b \leq x_2 \leq b\} \times \{-r \leq x_3 \leq r\}, \quad (5.10)$$

where $r = \varepsilon$ or $r \sim 1$, and a, b are positive constants. For $x = [x_1, x_2, x_3] \in \mathbb{R}^3$, let $w := [1, 1, 1]$ and

$$\begin{aligned} \mathbf{E}_1^\pm &= \{x : x^{\check{2}} \in \Omega_{w^{\check{2}}, r, 1}^{(p), \pm} \pm [a, 0, 0], -b \leq x_2 \leq b\}, \\ \mathbf{E}_2^\pm &= \{x : x^{\check{1}} \in \Omega_{w^{\check{1}}, r, 2}^{(p), \pm} \pm [0, b, 0], -a \leq x_1 \leq a\}, \end{aligned} \quad (5.11)$$

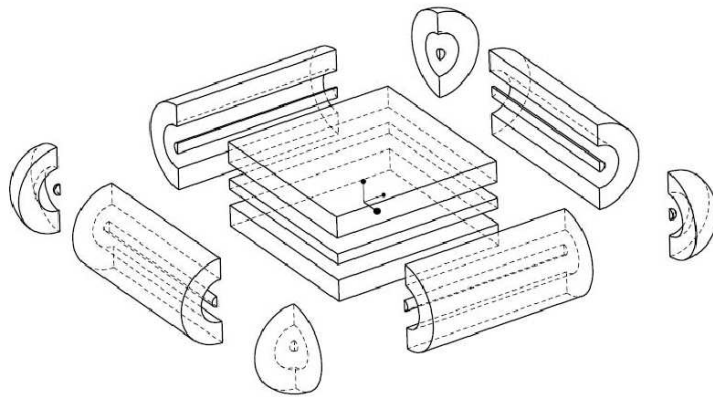

(a) Detached components in Type **E** cloak.

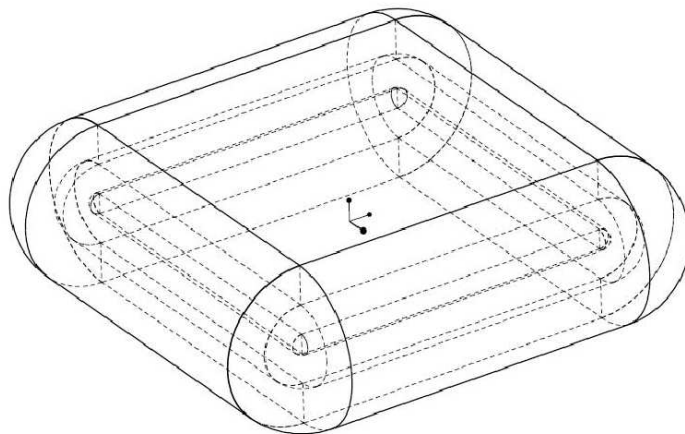

(b) Flat cloak with assembled components.

Figure 4: Schematic illustration for the construction of Type **E** cloaks.

and

$$\begin{aligned}\mathbf{E}_3^\pm &= \{x + [a, \pm b, 0] : x \in \Omega_{w,r}^{(p)} \text{ with } x_1 > 0 \text{ and } \pm x_2 > 0\}, \\ \mathbf{E}_4^\pm &= \{x + [-a, \pm b, 0] : x \in \Omega_{w,r}^{(p)} \text{ with } x_1 < 0 \text{ and } \pm x_2 > 0\}.\end{aligned}\quad (5.12)$$

Let

$$\mathbf{E}_{[w_0,r,a,b]} = \mathbf{E}_0 \cup \left(\bigcup_{l=1}^4 \mathbf{E}_l^\pm \right). \quad (5.13)$$

\mathbf{E} is a *rescue cushion* composed of nine components: the centered component \mathbf{E}_0 which is a cuboid of dimensions $2a, 2b$ and $2r$; four components $\mathbf{E}_{1,2}^\pm$ attached to the side faces and four components $\mathbf{E}_{3,4}^\pm$ assembled to the four corners. In our subsequent study, we would take $r = \varepsilon$ as the geometry in the virtual space while $r \sim 1$ as the geometry in the physical space.

5.2 Blow-up construction and concatenation

We shall be concerned with two basic types of blow-up transformations. Henceforth, let $r_2 > r_1 > \varepsilon > 0$. Set

$$F_\varepsilon(x) = (A + B|x|_{w,p}) \frac{x}{|x|_{w,p}}, \quad (5.14)$$

where

$$A = \frac{r_1 - \varepsilon}{r_2 - \varepsilon} r_2, \quad B = \frac{r_2 - r_1}{r_2 - \varepsilon}. \quad (5.15)$$

It is verified directly that F_ε blows up $\Omega_{w,\varepsilon}^{(p)}$ to $\Omega_{w,r_1}^{(p)}$ within $\Omega_{w,r_2}^{(p)}$, namely

$$F_\varepsilon \left(\Omega_{w,r_2}^{(p)} \setminus \overline{\Omega_{w,\varepsilon}^{(p)}} \right) = \Omega_{w,r_2}^{(p)} \setminus \overline{\Omega_{w,r_1}^{(p)}}, \quad F_\varepsilon|_{S_{w,r_2}^{(p)}} = \text{Identity}. \quad (5.16)$$

For A and B given in (5.15), we let

$$G_\varepsilon(x) = \begin{cases} (A + B|x_N|) \text{sign}(x_N), \\ x_l, \quad 1 \leq l \leq N-1 \end{cases} \quad (5.17)$$

and it can be verified that

$$G_\varepsilon(Q_{r_2} \setminus Q_\varepsilon) = Q_{r_2} \setminus Q_{r_1}, \quad G_\varepsilon|_{\Pi_{r_2}} = \text{Identity}, \quad (5.18)$$

where

$$\begin{aligned}Q_r &:= \{|x_l| \leq a_l : 1 \leq l \leq N-1\} \times \{|x_N| \leq r\}, \\ \Pi_r &:= \{|x_l| \leq a_l : 1 \leq l \leq N-1\} \times \{|x_N| = r\}.\end{aligned}$$

Now, by using blow-up transformations of type (5.14) or type (5.17), and concatenating each sub-component, it is straightforward to see that there exists a bi-Lipschitz and orientation-preserving map \mathcal{F}_1 , such that for the region constructed in (5.6)

$$\mathcal{F}_1(\mathbf{C}_{[w_0,r_2,a]} \setminus \mathbf{C}_{[w_0,\varepsilon,a]}) = \mathbf{C}_{[w_0,r_2,a]} \setminus \mathbf{C}_{[w_0,r_1,a]}, \quad \mathcal{F}_1|_{\partial \mathbf{C}_{[w_0,r_2,a]}} = \text{Identity}. \quad (5.19)$$

In a similar manner, one can show that for \mathbf{D} and \mathbf{E} , respectively, in (5.9) and (5.13), there exist \mathcal{G}_1 and \mathcal{H}_1 such that

$$\mathcal{G}_1 (\mathbf{D}_{[w,r_2,a]} \setminus \mathbf{D}_{[w,\varepsilon,a]}) = \mathbf{D}_{[w,r_2,a]} \setminus \mathbf{D}_{[w,r_1,a]}, \quad \mathcal{G}_1|_{\partial \mathbf{D}_{[w,r_2,a]}} = \text{Identity}, \quad (5.20)$$

and

$$\mathcal{H}_1 (\mathbf{E}_{[w_0,r_2,a,b]} \setminus \mathbf{E}_{[w_0,\varepsilon,a,b]}) = \mathbf{E}_{[w_0,r_2,a,b]} \setminus \mathbf{E}_{[w_0,r_1,a,b]}, \quad \mathcal{H}_1|_{\partial \mathbf{E}_{[w_0,r_2,a,b]}} = \text{Identity}. \quad (5.21)$$

5.3 Partial cloaking devices

With the preparations in Sections 5.1 and 5.2, we shall present our cloaking construction in this section. We start with a simple 2D case. Let \mathcal{F}_1 be given in (5.19) and set

$$\mathcal{F}(x) = \begin{cases} \text{Identity} & \text{for } x \in \mathbb{R}^2 \setminus \overline{\mathbf{C}}_{[w_0,r_2,a]}, \\ \mathcal{F}_1(x) & \text{for } x \in \mathbf{C}_{[w_0,r_2,a]} \setminus \overline{\mathbf{C}}_{[w_0,\varepsilon,a]}, \\ \mathcal{F}_s(x) & \text{for } x \in \mathbf{C}_{[w_0,\varepsilon,a]} = \mathbf{C}_L \cup \mathbf{C}_M \cup \mathbf{C}_R, \end{cases} \quad (5.22)$$

where

$$\mathcal{F}_s : x = \begin{pmatrix} x_1 \\ x_2 \end{pmatrix} \mapsto \begin{cases} \begin{pmatrix} \frac{r_1}{\varepsilon}(x_1 + a) - a \\ \frac{r_1}{\varepsilon}x_2 \end{pmatrix} & \text{for } x \in \mathbf{C}_L, \\ \begin{pmatrix} x_1 \\ \frac{r_1}{\varepsilon}x_2 \end{pmatrix} & \text{for } x \in \mathbf{C}_M, \\ \begin{pmatrix} \frac{r_1}{\varepsilon}(x_1 - a) + a \\ \frac{r_1}{\varepsilon}x_2 \end{pmatrix} & \text{for } x \in \mathbf{C}_R. \end{cases} \quad (5.23)$$

Clearly, we have that $\mathcal{F} : \mathbf{C}_{[w_0,r_2,a]} \rightarrow \mathbf{C}_{[w_0,r_2,a]}$ is bi-Lipschitz and orientation-preserving and $\mathcal{F}|_{\partial \mathbf{C}_{[w_0,r_2,a]}} = \text{Identity}$. Next, let

$$(\mathbf{C}_{[w_0,\varepsilon,a]} \setminus \overline{\mathbf{C}}_{[w_0,\varepsilon/2,a]}; \sigma_l^\varepsilon, q_l^\varepsilon), \quad \sigma_l^\varepsilon(x) = \begin{pmatrix} c_1(x) & 0 \\ 0 & c_2(x)\varepsilon^2 \end{pmatrix}, \quad q_l^\varepsilon(x) = (c_3(x) + ic_4(x))\varepsilon^{-1/2}, \quad (5.24)$$

where $c_l, 1 \leq l \leq 4$ are positive functions satisfying

$$\lambda_0 \leq c_l(x) \leq \Lambda_0 \quad \text{for a.e. } x \in \mathbf{C}_{[w_0,\varepsilon,a]} \setminus \overline{\mathbf{C}}_{[w_0,\varepsilon/2,a]},$$

with λ_0 and Λ_0 two positive constants independent of ε . Then we let

$$(\mathbf{C}_{[w_0,r_1,a]} \setminus \overline{\mathbf{C}}_{[w_0,r_1/2,a]}; \tilde{\sigma}^\varepsilon, \tilde{q}^\varepsilon) = \mathcal{F}_* (\mathbf{C}_{[w_0,\varepsilon,a]} \setminus \overline{\mathbf{C}}_{[w_0,\varepsilon/2,a]}; \sigma_l^\varepsilon, q_l^\varepsilon). \quad (5.25)$$

We further let

$$(\mathbf{C}_{[w_0,r_2,a]} \setminus \overline{\mathbf{C}}_{[w_0,r_1,a]}; \tilde{\sigma}^\varepsilon, \tilde{q}^\varepsilon) = \mathcal{F}_* (\mathbf{C}_{[w_0,r_2,a]} \setminus \overline{\mathbf{C}}_{[w_0,\varepsilon,a]}; I, 1). \quad (5.26)$$

Definition 5.1. Let $\tilde{\mathcal{C}}_{\mathbf{C}}^\varepsilon = (\Sigma_1, \Sigma_2, \Sigma_3, s, \tilde{\sigma}^\varepsilon, \tilde{q}^\varepsilon, h, H)$ be an admissible scattering configuration satisfying the following.

- i) $\Sigma_1, \Sigma_2, \Sigma_3$ are all contained and h, H are both supported in $\mathbf{C}_{[w_0, r_1/2, a]}$.
- ii) In the regions $\mathbf{C}_{[w_0, r_1, a]} \setminus \overline{\mathbf{C}}_{[w_0, r_1/2, a]}$ and $\mathbf{C}_{[w_0, r_2, a]} \setminus \overline{\mathbf{C}}_{[w_0, r_1, a]}$, $(\tilde{\sigma}^\varepsilon, \tilde{q}^\varepsilon)$ are, respectively, given by (5.25) and (5.26). Moreover, in $\mathbb{R}^2 \setminus \overline{\mathbf{C}}_{[w_0, r_2, a]}$, $\tilde{\sigma}^\varepsilon = I$ and $\tilde{q}^\varepsilon = 1$.
- iii) If $H \equiv 0$, then it is required that

$$\Im \tilde{q}^\varepsilon(x) \geq \lambda_0 \quad \text{for a.e. } x \in \text{supp}(h), \quad (5.27)$$

where λ_0 is a positive constant independent of ε .

- iv) If both H and h are not identically vanishing, then it is required that

$$\lambda_0 \leq \Im \tilde{q}^\varepsilon(x), \Re \tilde{q}^\varepsilon(x) \leq \Lambda_0 \quad \text{for a.e. } x \in \mathbf{C}_{[w_0, r_1/2, a]}, \quad (5.28)$$

and

$$\tilde{\sigma}^\varepsilon(x) \xi \cdot \xi \geq \lambda_0 \|\xi\|^2 \quad \text{for a.e. } x \in \text{supp}(H), \quad (5.29)$$

where λ_0 and Λ_0 are positive constants independent of ε .

Then, we have

Proposition 5.1. *Let $\tilde{\mathcal{C}}_\mathbf{C}^\varepsilon$ be as in Definition 5.1, and let $\tilde{u}_\infty^\varepsilon(\hat{x}, d) := u_\infty(\hat{x}, d; \tilde{\mathcal{C}}_\mathbf{C}^\varepsilon)$ be the scattering amplitude corresponding to the scattering configuration $\tilde{\mathcal{C}}_\mathbf{C}^\varepsilon$. Let $r_l \sim 1$, $l = 1, 2$ and $a \sim 1$ in $\mathbf{C}_{[w_0, a, r_l]}$ and let \mathcal{N}_τ be given in (4.17). Then there exists $\varepsilon_0 > 0$ and a function $\omega : (0, \varepsilon_0] \rightarrow (0, +\infty]$ with $\lim_{s \rightarrow 0^+} \omega(s) = 0$ such that for any $\varepsilon < \varepsilon_0$*

$$\|\tilde{u}_\infty^\varepsilon(\cdot, d)\|_{L^\infty(\mathbb{S}^1)} \leq \omega(\varepsilon) + C\tau \quad \text{for } d \in \mathcal{N}_\tau, \quad (5.30)$$

and

$$\|\tilde{u}_\infty^\varepsilon(\cdot, d)\|_{L^\infty(\mathcal{N}_\tau)} \leq \omega(\varepsilon) + C\tau \quad \text{for } d \in \mathbb{S}^1, \quad (5.31)$$

where C is the constant from Proposition 4.3 and ω is independent of $(\Sigma_1, \Sigma_2, \Sigma_3, s)$. Moreover, if $h \equiv 0$ and $H \equiv 0$, then ω is also independent of $(\mathbf{C}_{[w_0, r_1/2, a]}; \tilde{\sigma}^\varepsilon, \tilde{q}^\varepsilon)$; and if $H \equiv 0$, then ω is independent of $(\mathbf{C}_{[w_0, r_1/2, a]}; \tilde{\sigma}^\varepsilon, \Re \tilde{q}^\varepsilon, \Im \tilde{q}^\varepsilon|_{\{h=0\}})$; and if $h \not\equiv 0$ and $H \not\equiv 0$, then ω is independent of $\tilde{\sigma}^\varepsilon|_{\{H=0\}}$.

Proof. Let $\mathcal{C}_\mathbf{C}^\varepsilon = (K_1^\varepsilon, K_2^\varepsilon, K_3^\varepsilon, s^\varepsilon, \sigma^\varepsilon, q^\varepsilon, h^\varepsilon, H^\varepsilon)$ be defined by

$$\mathcal{C}_\mathbf{C}^\varepsilon := (\mathcal{F}^{-1})_* \tilde{\mathcal{C}}_\mathbf{C}^\varepsilon.$$

That is, $\mathcal{C}_\mathbf{C}^\varepsilon$ is the virtual configuration in the virtual space of the physical configuration $\tilde{\mathcal{C}}_\mathbf{C}^\varepsilon$ in the physical space. Then, by Lemma 2.1, we know $u_\infty(\hat{x}, d; \tilde{\mathcal{C}}_\mathbf{C}^\varepsilon) = u_\infty(\hat{x}, d; \mathcal{C}_\mathbf{C}^\varepsilon)$. Now, the proposition can be proved by combining Theorem 3.3 and Proposition 4.3, in a completely similar manner as for the proofs of Propositions 4.1 and 4.2. \square

Remark 5.1. By Proposition 5.1, we see that if τ and ε are chosen to be small, the construction corresponding to the scattering configuration $\widetilde{\mathbf{C}}_{\mathbf{C}}^{\varepsilon}$ yields a regularized partial cloak with a limited observation aperture \mathcal{N}_{τ} if the impinging angle is from \mathbb{S}^1 , and also a regularized partial cloak with a limited impinging aperture \mathcal{N}_{τ} and if the observation is from \mathbb{S}^1 . Moreover, in the cloaked region $\mathbf{C}_{[w_0, r_1/2, a]}$, if no source/sink (h, H) is presented, the passive medium inside could be arbitrary (but regular); and if a source/sink term h is presented, one only need impose the generic condition that at the place where the source/sink is located, the medium is absorbing.

Remark 5.2. The lossy layer (5.24)–(5.25) is only a very particular choice of illustrating our general theory. Indeed, one can devise more general lossy layers as long as Assumption 1, b) is satisfied. For example, one may choose the lossy layer in (5.24) to be $\sigma_l^{\varepsilon} = \varepsilon^2 I$ and $q_l^{\varepsilon} = (1 + i)\varepsilon^{-1/2}$. Moreover, with such a lossy layer, one could set the parameter a in defining $\mathbf{C}_{[w_0, r, a]}$ to be ε . In doing this, in the virtual space, $\mathbf{C}_{[w_0, \varepsilon, \varepsilon]}$ is ‘uniformly’ small and hence the construction $\widetilde{\mathbf{C}}_{\mathbf{C}}^{\varepsilon}$ would yield a full regularized cloak. Furthermore, we would like to note that by adjusting the parameter a , one can achieve a customized partial cloak. That is, for any given aperture \mathcal{N}_{τ} and any small $\delta > 0$, one can choose a sufficiently small ε and $a \in (\varepsilon, 1)$ such that $\|u^{\infty}(\cdot, d; \widetilde{\mathbf{C}}_{\mathbf{C}}^{\varepsilon})\|_{L^{\infty}(\mathbb{S}^1)} \leq \delta$ for $d \in \mathcal{N}_{\tau}$. This can be straightforwardly shown by combining Theorem 3.3 and Proposition 4.3. However, there is one point that one needs to take care of in (4.20). In (4.20), the constant C in the estimate is dependent on a . However, heuristically speaking, C could be independent of a for a from a certain range. If this is the case, the construction of the customized partial cloak holds, and we shall not explore further in this aspect in the current article.

For the three-dimensional ABC geometry \mathbf{D} , in a similar manner, one lets

$$\mathcal{G}(x) = \begin{cases} \text{Identity} & \text{for } x \in \mathbb{R}^3 \setminus \overline{\mathbf{D}}_{[w_0, r_2, a]}, \\ \mathcal{G}_1(x) & \text{for } x \in \mathbf{D}_{[w_0, r_2, a]} \setminus \overline{\mathbf{D}}_{[w, \varepsilon, a]}, \\ \mathcal{G}_s(x) & \text{for } x \in \mathbf{D}_{[w_0, \varepsilon, a]} = \mathbf{D}_L \cup \mathbf{D}_M \cup \mathbf{D}_R. \end{cases} \quad (5.32)$$

where

$$\mathcal{G}_s : x = \begin{pmatrix} x_1 \\ x_2 \\ x_3 \end{pmatrix} \mapsto \begin{cases} \begin{pmatrix} \frac{r_1}{\varepsilon}(x_1 + a) - a \\ \frac{r_1}{\varepsilon}x_2 \\ \frac{r_1}{\varepsilon}x_3 \end{pmatrix} & \text{for } x \in \mathbf{D}_L, \\ \begin{pmatrix} x_1 \\ \frac{r_1}{\varepsilon}x_2 \\ \frac{r_1}{\varepsilon}x_3 \end{pmatrix} & \text{for } x \in \mathbf{D}_M, \\ \begin{pmatrix} \frac{r_1}{\varepsilon}(x_1 - a) + a \\ \frac{r_1}{\varepsilon}x_2 \\ \frac{r_1}{\varepsilon}x_3 \end{pmatrix} & \text{for } x \in \mathbf{D}_R. \end{cases} \quad (5.33)$$

Then $\mathcal{G} : \mathbf{D}_{[w, r_2, a]} \rightarrow \mathbf{D}_{[w, r_2, a]}$ is bi-Lipschitz and orientation-preserving and $\mathcal{G}|_{\partial \mathbf{D}_{[w, r_2, a]}}$

= Identity. Next, we again introduce a lossy layer as follows

$$(\mathbf{D}_{[w,\varepsilon,a]} \setminus \overline{\mathbf{D}}_{[w,\varepsilon/2,a]}; \sigma_l^\varepsilon, q_l^\varepsilon), \quad \sigma_l^\varepsilon = c_1 \varepsilon^2 I, \quad q_l^\varepsilon = (c_2 + ic_3) \varepsilon^{-1/2}, \quad (5.34)$$

where $c_l, 1 \leq l \leq 3$ are positive constants, and let

$$(\mathbf{D}_{[w,r_1,a]} \setminus \overline{\mathbf{D}}_{[w,r_1/2,a]}; \tilde{\sigma}^\varepsilon, \tilde{q}^\varepsilon) = \mathcal{G}_* (\mathbf{D}_{[w,\varepsilon,a]} \setminus \overline{\mathbf{D}}_{[w,\varepsilon/2,a]}; \sigma_l^\varepsilon, q_l^\varepsilon). \quad (5.35)$$

We also let

$$(\mathbf{D}_{[w,r_2,a]} \setminus \overline{\mathbf{D}}_{[w,r_1,a]}; \tilde{\sigma}^\varepsilon, \tilde{q}^\varepsilon) = \mathcal{G}_* (\mathbf{D}_{[w,r_2,a]} \setminus \mathbf{D}_{[w,\varepsilon,a]}; I, 1), \quad (5.36)$$

Definition 5.2. Let $\tilde{\mathcal{C}}_{\mathbf{D}}^\varepsilon = (\Sigma_1, \Sigma_2, \Sigma_3, s, \tilde{\sigma}^\varepsilon, \tilde{q}^\varepsilon, h, H)$ be an admissible scattering configuration satisfying the following.

- i) $\Sigma_1, \Sigma_2, \Sigma_3$ are all contained and h, H are both supported in $\mathbf{D}_{[w,r_1/2,a]}$.
- ii) In the regions $\mathbf{D}_{[w,r_1,a]} \setminus \overline{\mathbf{D}}_{[w,r_1/2,a]}$ and $\mathbf{D}_{[w,r_2,a]} \setminus \overline{\mathbf{D}}_{[w,r_1,a]}$, $(\tilde{\sigma}^\varepsilon, \tilde{q}^\varepsilon)$ are, respectively, given by (5.35) and (5.36). Moreover, in $\mathbb{R}^3 \setminus \overline{\mathbf{D}}_{[w,r_2,a]}$, $\tilde{\sigma}^\varepsilon = I$ and $\tilde{q}^\varepsilon = 1$.
- iii) If $H \equiv 0$, then it is required that

$$\Im \tilde{q}^\varepsilon(x) \geq \lambda_0 \quad \text{for a.e. } x \in \text{supp}(h), \quad (5.37)$$

where λ_0 is a positive constant independent of ε .

- iv) If both H and h are not identically vanishing, then it is required that

$$\lambda_0 \leq \Im \tilde{q}^\varepsilon(x), \Re \tilde{q}^\varepsilon(x) \leq \Lambda_0 \quad \text{for a.e. } x \in \mathbf{D}_{[w,r_1/2,a]}, \quad (5.38)$$

and

$$\tilde{\sigma}^\varepsilon(x) \xi \cdot \xi \geq \lambda_0 \|\xi\|^2 \quad \text{for a.e. } x \in \text{supp}(H), \quad (5.39)$$

where λ_0 and Λ_0 are positive constants independent of ε .

Then, we have

Proposition 5.2. *Let $\tilde{\mathcal{C}}_{\mathbf{D}}^\varepsilon$ be as in Definition 5.2, and let $\tilde{u}_\infty^\varepsilon(\hat{x}, d) := u_\infty(\hat{x}, d; \tilde{\mathcal{C}}_{\mathbf{D}}^\varepsilon)$ be the scattering amplitude corresponding to the scattering configuration $\tilde{\mathcal{C}}_{\mathbf{D}}^\varepsilon$. Let $r_l \sim 1, l = 1, 2$ and $a \sim 1$ in $\mathbf{D}_{[w,a,r_l]}$. Then there exists $\varepsilon_0 > 0$ and a function $\omega : (0, \varepsilon_0] \rightarrow (0, +\infty]$ with $\lim_{s \rightarrow 0^+} \omega(s) = 0$ such that for any $\varepsilon < \varepsilon_0$*

$$\|\tilde{u}_\infty^\varepsilon(\cdot, d)\|_{L^\infty(\mathbb{S}^2)} \leq \omega(\varepsilon) \quad \text{for } d \in \mathbb{S}^2. \quad (5.40)$$

where ω is independent of $(\Sigma_1, \Sigma_2, \Sigma_3, s)$. Moreover, if $h \equiv 0$ and $H \equiv 0$, then ω is also independent of $(\mathbf{D}_{[w,r_1/2,a]}; \tilde{\sigma}^\varepsilon, \tilde{q}^\varepsilon)$; and if $H \equiv 0$, then ω is independent of $(\mathbf{D}_{[w,r_1/2,a]}; \tilde{\sigma}^\varepsilon, \Re \tilde{q}^\varepsilon, \Im \tilde{q}^\varepsilon|_{\{h=0\}})$; and if $h \not\equiv 0$ and $H \not\equiv 0$, then ω is independent of $\tilde{\sigma}^\varepsilon|_{\{H=0\}}$.

Proof. The proof can be obtained in a similar manner to that for Proposition 5.1. The major different point is that $\mathbf{D}_{[w,\varepsilon,\varepsilon]}$ in the virtual space degenerates to a line-segment as $\varepsilon \rightarrow 0^+$, which has zero capacity in \mathbb{R}^3 . Hence, one would have a regularized full cloak for the construction corresponding to $\tilde{\mathcal{C}}_{\mathbf{D}}^\varepsilon$; see also the proofs of Propositions 4.1 and 4.2. \square

Remark 5.3. Similar to Remark 5.2, the lossy layer (5.34)–(5.35) is only a very particular choice for illustrating our general theory. Indeed, one can also devise much more general lossy layers as long as Assumption 1, b) is satisfied. For example, one may choose an anisotropic lossy layer with variable coefficients as the one in (5.24). Moreover, we would like to remark that by adjusting the free parameter a to be smaller in $\mathbf{D}_{[w,r,a]}$, one can improve the accuracy of approximation for the cloak construction corresponding to $\tilde{\mathcal{C}}_{\mathbf{D}}^\varepsilon$.

Finally, for the ABC geometry \mathbf{E} , one can introduce

$$\mathcal{H}(x) = \begin{cases} \text{Identity} & \text{for } x \in \mathbb{R}^3 \setminus \overline{\mathbf{E}}_{[w_0,r_2,a,b]}, \\ \mathcal{H}_1(x) & \text{for } x \in \mathbf{E}_{[w_0,r_2,a,b]} \setminus \overline{\mathbf{E}}_{[w_0,\varepsilon,a,b]}, \\ \mathcal{H}_s(x) & \text{for } x \in \mathbf{E}_{[w_0,\varepsilon,a,b]} = \mathbf{E}_0 \cup \left(\bigcup_{l=1}^4 \mathbf{E}_l^\pm \right), \end{cases} \quad (5.41)$$

where

$$\mathcal{H}_s : x = \begin{pmatrix} x_1 \\ x_2 \\ x_3 \end{pmatrix} \mapsto \begin{cases} \begin{pmatrix} x_1 \\ x_2 \\ \frac{r_1}{\varepsilon} x_3 \end{pmatrix} & \text{for } x \in \mathbf{E}_0, \\ \begin{pmatrix} \frac{r_1}{\varepsilon} (x_1 \mp a) \pm a \\ x_2 \\ \frac{r_1}{\varepsilon} x_3 \end{pmatrix} & \text{for } x \in \mathbf{E}_1^\pm, \\ \begin{pmatrix} x_1 \\ \frac{r_1}{\varepsilon} (x_2 \mp b) \pm b \\ \frac{r_1}{\varepsilon} x_3 \end{pmatrix} & \text{for } x \in \mathbf{E}_2^\pm, \\ \begin{pmatrix} \frac{r_1}{\varepsilon} (x_1 - a) + a \\ \frac{r_1}{\varepsilon} (x_2 \mp b) \pm b \\ \frac{r_1}{\varepsilon} x_3 \end{pmatrix} & \text{for } x \in \mathbf{E}_3^\pm, \\ \begin{pmatrix} \frac{r_1}{\varepsilon} (x_1 + a) - a \\ \frac{r_1}{\varepsilon} (x_2 \mp b) \pm b \\ \frac{r_1}{\varepsilon} x_3 \end{pmatrix} & \text{for } x \in \mathbf{E}_4^\pm. \end{cases} \quad (5.42)$$

Let a particular lossy layer be chosen to be

$$(\mathbf{E}_{[w_0,r_1,a,b]} \setminus \overline{\mathbf{E}}_{[w_0,r_1/2,a,b]}; \tilde{\sigma}^\varepsilon, \tilde{q}^\varepsilon) = \mathcal{H}_* (\mathbf{E}_{[w_0,\varepsilon,a,b]} \setminus \overline{\mathbf{E}}_{[w_0,\varepsilon/2,a,b]}; \sigma_l^\varepsilon, q_l^\varepsilon), \quad (5.43)$$

with

$$(\mathbf{E}_{[w_0,\varepsilon,a,b]} \setminus \overline{\mathbf{E}}_{[w_0,\varepsilon/2,a,b]}; \sigma_l^\varepsilon, q_l^\varepsilon), \quad \sigma_l^\varepsilon = c_1 \varepsilon^2 I, \quad q_l^\varepsilon = (c_2 + ic_3) \varepsilon^{-1/2}, \quad (5.44)$$

where $c_l, 1 \leq l \leq 3$ are positive constants. Set the cloaking medium to be

$$(\mathbf{E}_{[w_0, r_2, a, b]} \setminus \overline{\mathbf{E}}_{[w_0, r_1, a, b]}; \tilde{\sigma}^\varepsilon, \tilde{q}^\varepsilon) = \mathcal{H}_* (\mathbf{E}_{[w_0, r_2, a, b]} \setminus \mathbf{E}_{[w_0, \varepsilon, a, b]}; I, 1). \quad (5.45)$$

Definition 5.3. Let $\tilde{\mathcal{C}}_{\mathbf{E}}^\varepsilon = (\Sigma_1, \Sigma_2, \Sigma_3, s, \tilde{\sigma}^\varepsilon, \tilde{q}^\varepsilon, h, H)$ be an admissible scattering configuration satisfying the following.

- i) $\Sigma_1, \Sigma_2, \Sigma_3$ are all contained and h, H are both supported in $\mathbf{E}_{[w_0, r_1/2, a, b]}$.
- ii) In the regions $\mathbf{E}_{[w_0, r_1, a, b]} \setminus \overline{\mathbf{E}}_{[w_0, r_1/2, a, b]}$ and $\mathbf{E}_{[w_0, r_2, a, b]} \setminus \overline{\mathbf{E}}_{[w_0, r_1, a, b]}$, $(\tilde{\sigma}^\varepsilon, \tilde{q}^\varepsilon)$ are, respectively, given by (5.43) and (5.45). Moreover, in $\mathbb{R}^3 \setminus \overline{\mathbf{E}}_{[w_0, r_2, a, b]}$, $\tilde{\sigma}^\varepsilon = I$ and $\tilde{q}^\varepsilon = 1$.
- iii) If $H \equiv 0$, then it is required that

$$\Im \tilde{q}^\varepsilon(x) \geq \lambda_0 \quad \text{for a.e. } x \in \text{supp}(h), \quad (5.46)$$

where λ_0 is a positive constant independent of ε .

- iv) If both H and h are not identically vanishing, then it is required that

$$\lambda_0 \leq \Im \tilde{q}^\varepsilon(x), \Re \tilde{q}^\varepsilon(x) \leq \Lambda_0 \quad \text{for a.e. } x \in \mathbf{E}_{[w_0, r_1/2, a, b]}, \quad (5.47)$$

and

$$\tilde{\sigma}^\varepsilon(x) \xi \cdot \xi \geq \lambda_0 \|\xi\|^2 \quad \text{for a.e. } x \in \text{supp}(H), \quad (5.48)$$

where λ_0 and Λ_0 are positive constants independent of ε .

Then, we have

Proposition 5.3. *Let $\tilde{\mathcal{C}}_{\mathbf{E}}^\varepsilon$ be as in Definition 5.3, and let $\tilde{u}_\infty^\varepsilon(\hat{x}, d) := u_\infty(\hat{x}, d; \tilde{\mathcal{C}}_{\mathbf{E}}^\varepsilon)$ be the scattering amplitude corresponding to the scattering configuration $\tilde{\mathcal{C}}_{\mathbf{E}}^\varepsilon$. Let $r_l \sim 1$, $l = 1, 2$ and $a, b \sim 1$ in $\mathbf{E}_{[w_0, r_l, a, b]}$ and let \mathcal{N}_τ be given in (4.17). Then there exists $\varepsilon_0 > 0$ and a function $\omega : (0, \varepsilon_0] \rightarrow (0, +\infty]$ with $\lim_{s \rightarrow 0^+} \omega(s) = 0$ such that for any $\varepsilon < \varepsilon_0$*

$$\|\tilde{u}_\infty^\varepsilon(\cdot, d)\|_{L^\infty(\mathbb{S}^2)} \leq \omega(\varepsilon) + C\tau \quad \text{for } d \in \mathcal{N}_\tau, \quad (5.49)$$

and

$$\|\tilde{u}_\infty^\varepsilon(\cdot, d)\|_{L^\infty(\mathcal{N}_\tau)} \leq \omega(\varepsilon) + C\tau \quad \text{for } d \in \mathbb{S}^2, \quad (5.50)$$

where C is the constant from Proposition 4.3 and ω is independent of $(\Sigma_1, \Sigma_2, \Sigma_3, s)$. Moreover, if $h \equiv 0$ and $H \equiv 0$, then ω is also independent of $(\mathbf{E}_{[w_0, r_1/2, a, b]}; \tilde{\sigma}^\varepsilon, \tilde{q}^\varepsilon)$; and if $H \equiv 0$, then ω is independent of $(\mathbf{E}_{[w_0, r_1/2, a, b]}; \tilde{\sigma}^\varepsilon, \Re \tilde{q}^\varepsilon, \Im \tilde{q}^\varepsilon|_{\{h=0\}})$; and if $h \not\equiv 0$ and $H \not\equiv 0$, then ω is independent of $\tilde{\sigma}^\varepsilon|_{\{H=0\}}$.

Proof. The proof follows in a similar manner to that for Proposition 5.1. \square

Remark 5.4. Similar to Remark 5.2, the lossy layer (5.43)–(5.44) is only a very particular choice for illustrating our general theory. One can also devise much more general lossy layers as long as Assumption 1, b) is satisfied and it could be anisotropic with variable coefficients as the one in (5.24). Also analogously to Remark 5.2, by adjusting the two parameters a and b , one may have a customized partial cloak by the construction corresponding to $\tilde{\mathcal{C}}_{\mathbf{E}}^\varepsilon$.

6 Numerical results and discussion

In this section, we carry out systematic experiments based on the discussions in Sections 4 and 5 to investigate the cloaking performance with respect to the regularization parameter ε in two and three dimensions. Numerical simulations are carried out by employing the C++/Matlab coupled programming and the pardiso solver. Finite element method is used in a truncated domain coated by a perfectly matched layer to evaluate the performance of the proposed cloaks. The far-field pattern of the scattered field is calculated via the Kirchhoff-Helmholtz formula by surface integral on a sphere, within which the cloaking medium is compactly imbedded.

In the following experiments, we use the $L^\infty(\mathbb{S}^{N-1})$ -norm of the far-field patterns $\mathcal{A}_{\mathbf{T}}(\cdot, d) := u_\infty(\cdot, d; \tilde{\mathcal{C}}_{\mathbf{T}}^\varepsilon)$ ($\mathbf{T} = \mathbf{C}, \mathbf{D},$ or \mathbf{E}) to evaluate the cloaking performance of the specific cloaks. More precisely, we compute the module of the far field patterns on 100 equidistant points along the unit circle in two dimensions, or 100×100 points on the unit sphere by choosing uniformly distributed polar angles and azimuth angles in three dimensions, respectively. The exact value of the norm of $u_\infty(\cdot, d; \tilde{\mathcal{C}}_{\mathbf{T}}^\varepsilon)$ is then approximated by the maximum value of these modules, which is adopted for the performance evaluation of cloaks.

6.1 2D cloaks

For acoustic scattering in two dimensions, let the incident wave be a plane wave of wavelength $l_e = 2$. We choose $a = 1 \gg \varepsilon$ to test partial cloaks and $a = \varepsilon$ to check full cloaks.

First of all, we study the scattering performance of Type **C** cloaks. Let us visualize the effect of the l^1 , l^2 and l^∞ cloaks of Type **C** by looking at the instantaneous pressure. As shown by Figure 5, the total acoustic pressure is bent and/or compressed in the cloaking medium. There is clearly a thin surface layer within the lossy layer between the cloaked and cloaking regions and prevents the incident wave from penetrating into the cloaked region when the incident direction is parallel to the axial direction of Type **C** cloaks. At the mean time, the total pressure outside the cloaking media deviates only slightly from that of a perfectly plane wave (except tiny numerical deviation due to the finite spatial resolution in numerical simulations).

Next, we test the performance of the 2D l^2 partial cloak in case of tilted incident angles. From the instantaneous pressure in Figure 6(a), (b) and (c), it can be observed that there is increasingly more pressure deviation of the total field from that of a perfectly plane wave outside the cloak when we increase the incident angle from 5 and 10 to 20 degrees. When the incident angle is perpendicular to the axial direction of the partial cloak, strong scattering amplitude occurs and this suggests the failure at the extreme case, see Figure 6(d).

By symmetry, the same observation can be explained from the other side of the partial cloak. Figure 7 shows the far field pattern in decimal Bell [dB] with respect to the polar angle. It can be seen that when the incident direction is along the ideal axis

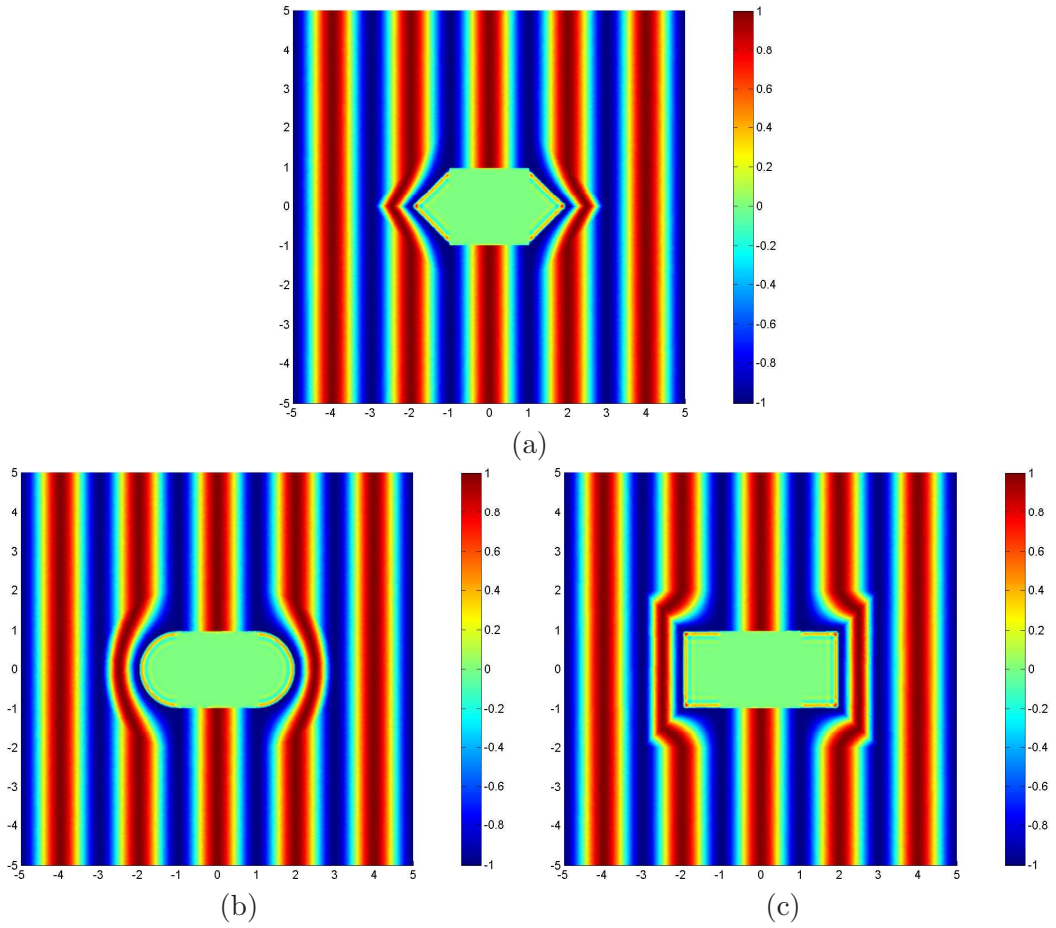

Figure 5: Real part of instantaneous acoustic pressure distribution using two-dimensional (a) l^1 , (b) l^2 and (c) l^∞ cloaks, respectively. Incident plane wave from left to right. Parameters: $\varepsilon = 10^{-2}$, $r_1 = 1$, $r_2 = 2$, $a = 1$.

(x-axis, namely 0 or 180 degrees in polar angle), the far field is always below -40 dB¹, which is small and negligible in practice. Figure 6(a) suggest that for a small tilted incident angle below 5 degrees, approximate partial cloak effects can be achieved with the far-field pattern below -20 dB.

In addition, there does exist some angle $\tau \sim 15, 7$ and 3 degrees corresponding to the tilted incident angles $5, 10$ and 20 , respectively, such that with such limited observation aperture perturbed off the ideal axis, the far field patterns are still below -40 dB (cf. cusps near the x -axis within the -40 dB contour curve in Figure 7). Hence (5.31) of Proposition 5.1 is confirmed numerically. That is, the partial cloaking is still in effect in a limited observation aperture around the ideal direction parallel to the cloak even for full impinging aperture.

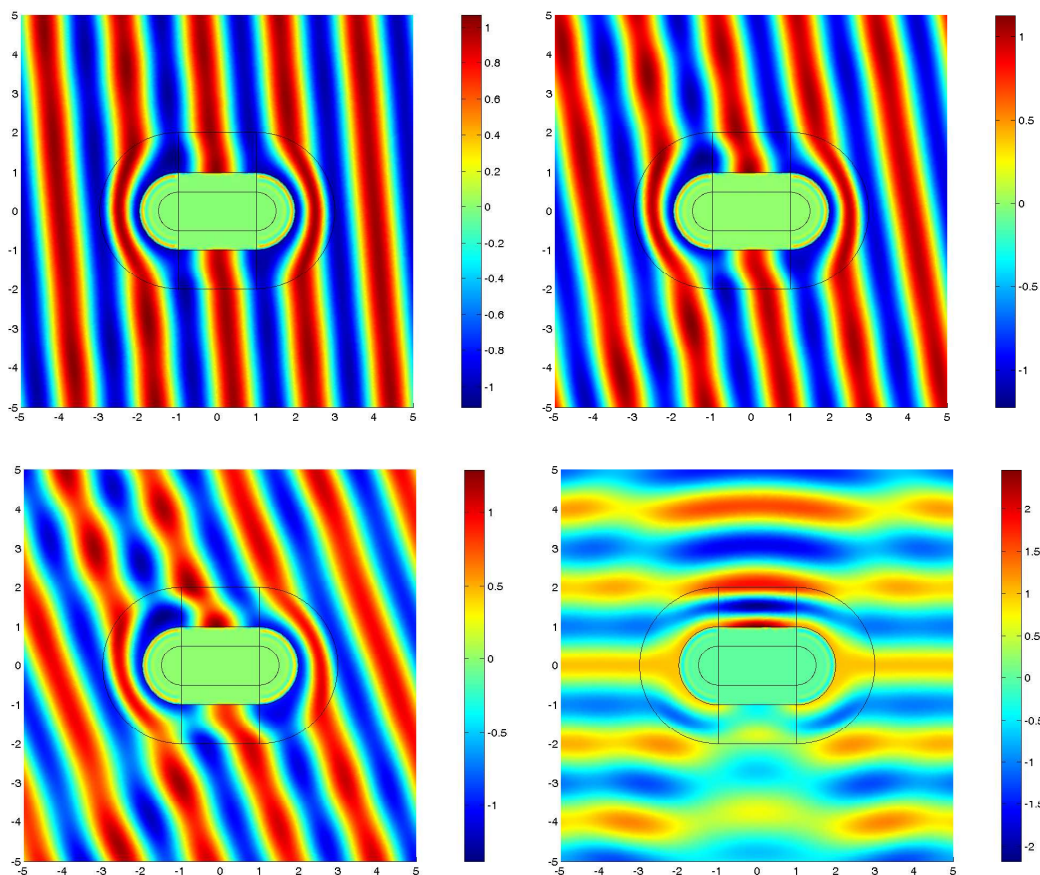

Figure 6: (From left to right) Real part of instantaneous acoustic pressure distribution using two-dimensional l^2 cloak with titled incident angles, 5, 10, 20 and 90 degrees, respectively. Parameters: $\varepsilon = 10^{-2}$, $r_1 = 1$, $r_2 = 2$, $a = 1$.

¹ -40 dB amounts to 10^{-4} in magnitude in far field patterns as opposed to the unit magnitude in the incident wave

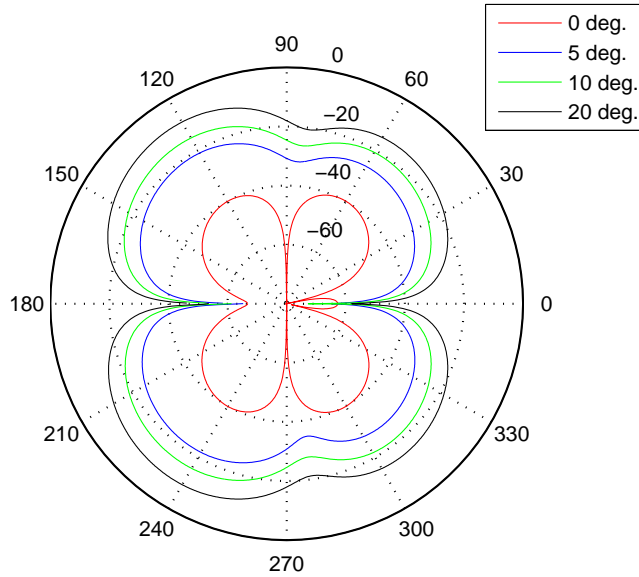

Figure 7: Polar plot of far field pattern as a function of polar angle using two-dimensional l^2 cloak with tilted incident angles, 0, 5, 10 and 20 degrees, respectively.

Finally, for the regularized full cloak case, we set $a = \varepsilon$ and the incident angle even perpendicular to the axial direction of the cloak and test the cloaking performance for the l^2 cloak of Type **C**. It can be observed from Figure 8 that compared with the red reference line denoting the second order decay rate, the far field pattern decays quadratically with respect to ε . That is, the construction yields an approximate full cloak within ε^2 -accuracy of the ideal full cloak. This observation complies with Remark 5.2. Moreover, the second order rate of approximation complies with the estimate in [28] for regularized full cloaks. Similar observations are made for l^1 and l^∞ cloaks of Type **C**.

6.2 3D cloaks

In the 3D cloaks, we fix the wavelength $l_e = 3$ and the regularization parameter $\varepsilon = 10^{-2}$ in acoustic scattering and use the spherical domain with radius 5 centered at the origin as the truncated domain for numerical simulations.

First, we check the cloaking performance of Type **D** cloaks in terms of a . All the impinging direction of the incident wave is perpendicular to the axial direction of the cloaks. It is noted that we always adopt the 3D l^2 cloak and the right angle incidence for tests. Similar observations are made for other combinations.

We show in Figure 9(a) the plane impinging wave with the incident direction along the x -axis. The resulting scattered wave is depicted in Figure 9(b), which nearly vanishes outside the cloak. In Figure 9(c), it can be obviously seen that the total wave is bent

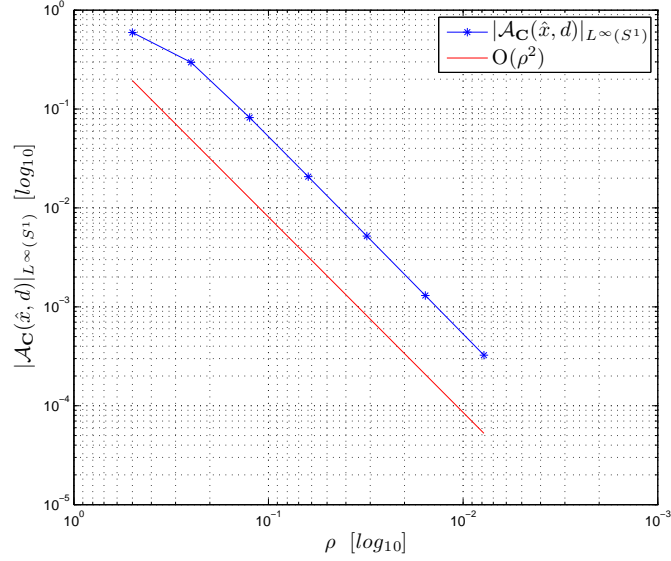

Figure 8: Convergence history of scattering measurement data versus ε for the 2D l^2 cloak when $a = \varepsilon$.

and compressed within the cloaking medium.

For a full 3D cloak with $a = \varepsilon$, Figure 10 demonstrates the third order approximation of the far-field pattern with respect to ε . That is, the construction yields an approximate full cloak within ε^3 -accuracy of the ideal full cloak, which is consistent with the result in [28] for regularized full cloaks obtained by blowing up a ‘uniformly’ small region in the virtual space. As we increase a to be 1, the far-field pattern decays only quadratically in terms of ε , see Figure 11. In other words, the construction by blowing up a ‘partially’ small region in the virtual space will suffer a reduction in the rate of approximation. This observation complies with Remark 5.3.

Finally, we investigate the 3D cloak of type **E** proposed in Definition 5.3. We choose fixed length $a = 1$ and width $b = 1$ but vary the regularization parameter ε . The incident plane wave is impinging upon the **E** cloak along the x -direction which is parallel to the xy plane where the type **E** cloak lies. Figure 12 shows us the scattered and total pressure fields in sliced plots. Obviously the scattered field is almost null outside the cloak, while the total field behaves nearly perfectly through the cloak by bending and compressing in the cloaking medium.

Acknowledgement

The work of Jingzhi Li is supported by the NSF of China. (No. 11201453 and 91130022). The work of Hongyu Liu is supported by NSF grant, DMS 1207784. Luca Rondi is partly supported by Università degli Studi di Trieste through Finanziamento per Ricercatori di Ateneo 2009 and by GNAMPA, INdAM, through 2012 projects. The work of Gunther

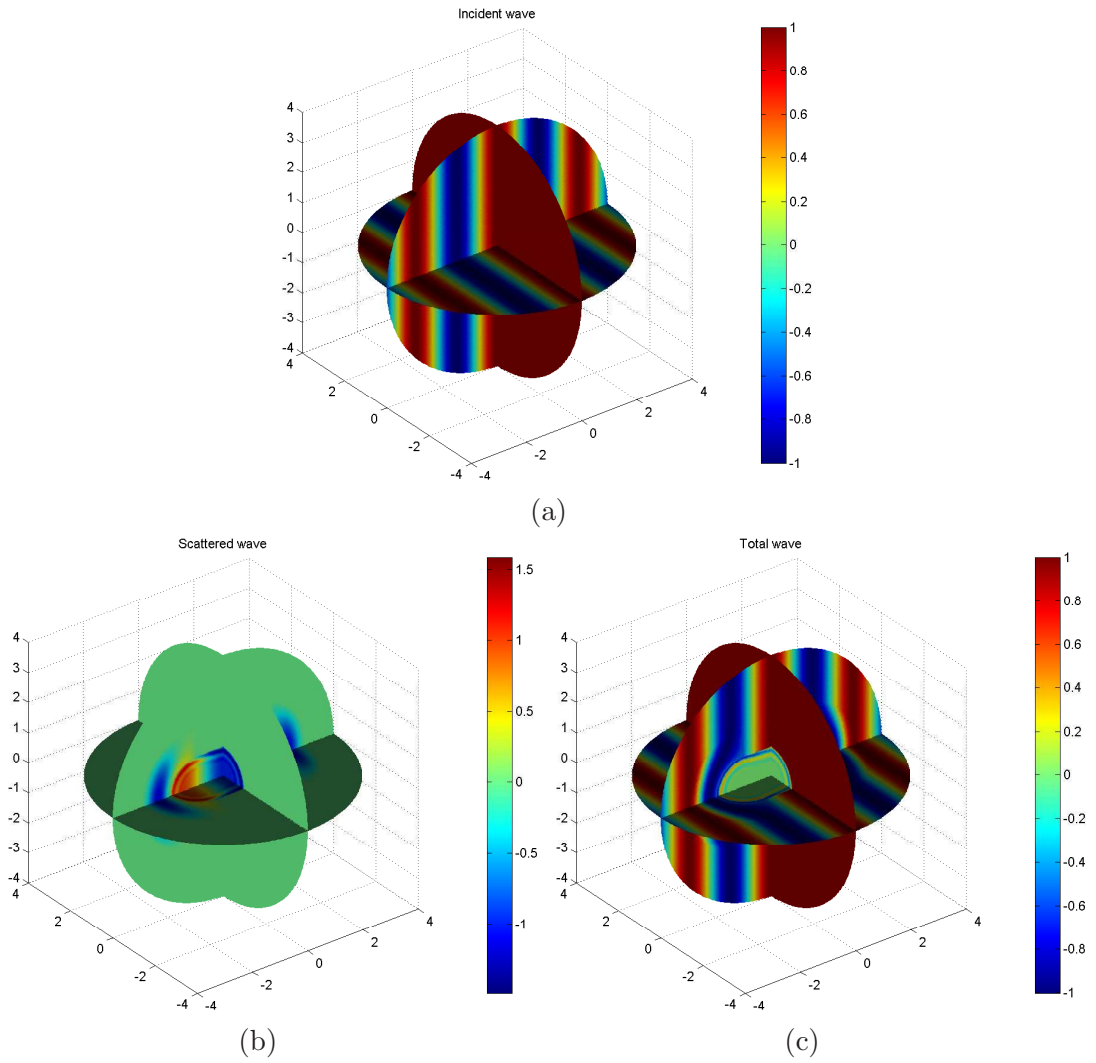

Figure 9: Type **D** when $\varepsilon = 0.01$: Real part of (a) the incident plane wave $\exp\{ikx \cdot d_0\}$, (b) the scattered field and (c) the total field sliced at $x = 0$, $z = 0$ and $y = 0$, respectively.

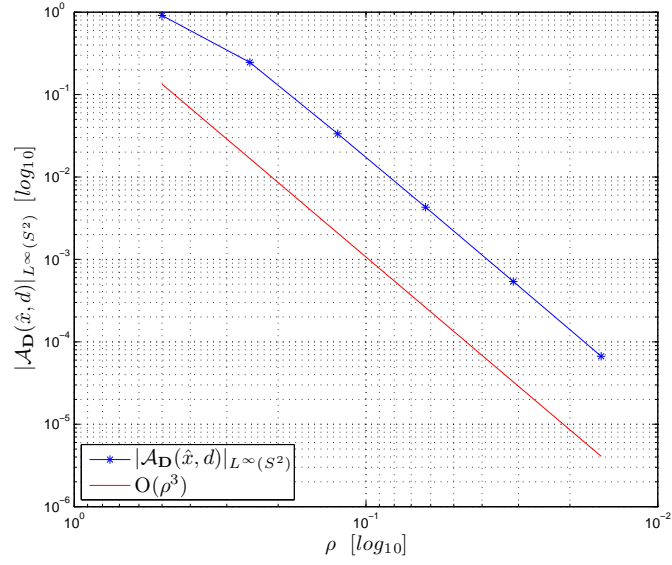

Figure 10: Convergence history of scattering measurement data versus ε for the 3D l^2 cloak \mathbf{D} when $a = \varepsilon$.

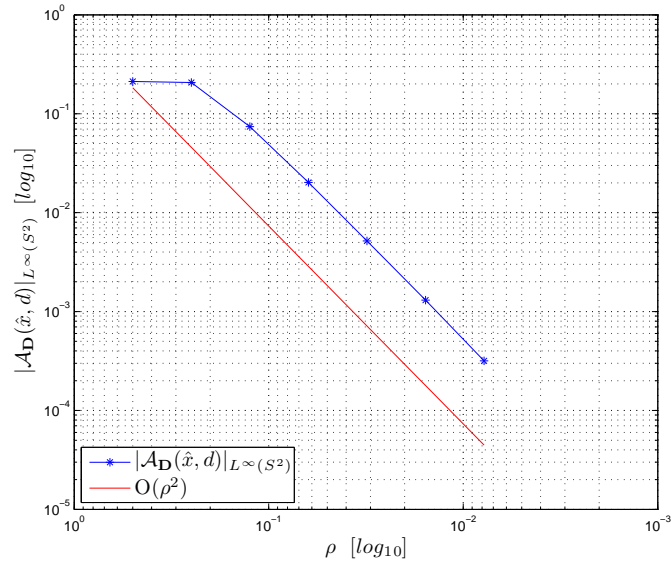

Figure 11: Convergence history of scattering measurement data versus ε for 3D l^2 cloak \mathbf{D} when $a = 1$ and ε varies.

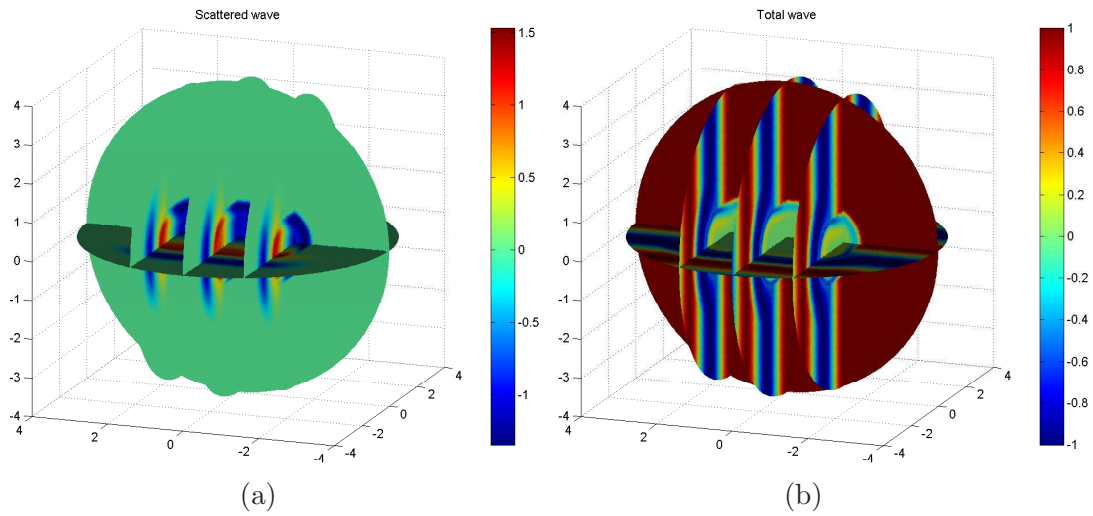

Figure 12: Type **E** when $\varepsilon = 0.01$: Real part of (a) the scattered field and (b) the total field sliced at $x = 0$, $z = 0$ and $y = -1.5, 0$ and 1.5 , respectively.

Uhlmann is partly supported by NSF and the Fondation des Sciences Mathématiques de Paris.

References

- [1] R. A. Adams, *Sobolev Spaces*, Academic Press, New York, 1975.
- [2] A. Alu and N. Engheta, *Achieving transparency with plasmonic and metamaterial coatings*, Phys. Rev. E, **72** (2005), 016623.
- [3] H. Ammari, G. Ciraolo, H. Kang, H. Lee and G. Milton, *Spectral analysis of a Neumann-Poincaré operator and analysis of cloaking due to anomalous localized resonance*, Arch. Ration. Mech. Anal., at press.
- [4] H. Ammari, J. Garnier, V. Jugnon, H. Kang, M. Lim and H. Lee, *Enhancement of near-cloaking. Part III: Numerical simulations, statistical stability, and related questions*, Contemporary Mathematics, **577** (2012), 1–24.
- [5] H. Ammari, H. Kang, H. Lee and M. Lim, *Enhancement of near-cloaking using generalized polarization tensors vanishing structures. Part I: The conductivity problem*, Comm. Math. Phys., **317** (2013), 253–266.
- [6] H. Ammari, H. Kang, H. Lee and M. Lim, *Enhancement of near-cloaking. Part II: The Helmholtz equation*, Comm. Math. Phys., **317** (2013), 485–502.
- [7] F. Cakoni and D. Colton, *Qualitative Methods in Inverse Scattering Theory*, Springer-Verlag, Berlin Heidelberg, 2006.

- [8] H. Chen and C. T. Chan, *Acoustic cloaking and transformation acoustics*, J. Phys. D: Appl. Phys., **43** (2010), 113001.
- [9] D. Colton and R. Kress, *Inverse Acoustic and Electromagnetic Scattering Theory*, 2nd Edition, Springer-Verlag, Berlin, 1998.
- [10] A. Greenleaf, Y. Kurylev, M. Lassas and G. Uhlmann, *Improvement of cylindrical cloaking with SHS lining*, Optics Express, **15** (2007), 12717–12734.
- [11] A. Greenleaf, Y. Kurylev, M. Lassas and G. Uhlmann, *Full-wave invisibility of active devices at all frequencies*, Comm. Math. Phys., **279** (2007), 749–789.
- [12] A. Greenleaf, Y. Kurylev, M. Lassas and G. Uhlmann, *Isotropic transformation optics: approximate acoustic and quantum cloaking*, New J. Phys., **10** (2008), 115024.
- [13] A. Greenleaf, Y. Kurylev, M. Lassas, and G. Uhlmann, *Electromagnetic wormholes via handlebody constructions*, Comm. Math. Phys., **281** (2008), 369–385.
- [14] A. Greenleaf, Y. Kurylev, M. Lassas and G. Uhlmann, *Invisibility and inverse problems*, Bulletin A. M. S., **46** (2009), 55–97.
- [15] A. Greenleaf, Y. Kurylev, M. Lassas and G. Uhlmann, *Cloaking devices, electromagnetic wormholes and transformation optics*, SIAM Review, **51** (2009), 3–33.
- [16] A. Greenleaf, M. Lassas and G. Uhlmann, *Anisotropic conductivities that cannot be detected by EIT*, Physiolog. Meas, (special issue on Impedance Tomography), **24** (2003), 413.
- [17] A. Greenleaf, M. Lassas and G. Uhlmann, *On nonuniqueness for Calderón’s inverse problem*, Math. Res. Lett., **10** (2003), 685–693.
- [18] V. Isakov, *Inverse Problems for Partial Differential Equations*, 2nd Edition, Springer-Verlag, New York, 2006.
- [19] I. Kocyyigit, H. Y. Liu and H. Sun, *Regular scattering patterns from near-cloaking devices and their implications for invisibility cloaking*, preprint, 2012.
- [20] R. Kohn, O. Onofrei, M. Vogelius and M. Weinstein, *Cloaking via change of variables for the Helmholtz equation*, Comm. Pure Appl. Math., **63** (2010), 973–1016.
- [21] R. Kohn, H. Shen, M. Vogelius and M. Weinstein, *Cloaking via change of variables in electrical impedance tomography*, Inverse Problems, **24** (2008), 015016.
- [22] U. Leonhardt, *Optical conformal mapping*, Science, **312** (2006), 1777–1780.
- [23] J. Li, H. Y. Liu and H. Sun, *Enhanced approximate cloaking by SH and FSH lining*, Inverse Problems, **28** (2012), 075011.
- [24] J. Li and J. B. Pendry, *Hiding under the carpet: a new strategy for cloaking*, Phys. Rev. Lett., **101** (2008), 203901.

- [25] J.L. Lions and E. Magenes, *Non-Homogeneous Boundary Value Problems and Applications I*, Springer-Verlag, 1970.
- [26] H. Y. Liu, *Virtual reshaping and invisibility in obstacle scattering*, Inverse Problems, **25** (2009), 045006.
- [27] H. Y. Liu, Z. Shang, H. Sun and J. Zou, *Singular perturbation of reduced wave equation and scattering from an embedded obstacle*, J. Dyn. Diff. Eq., **24** (2012), 803–821.
- [28] H. Y. Liu and H. Sun, *Enhanced near-cloak by FSH lining*, J. Math. Pures Appl., **99** (2013), 17–42.
- [29] H. Y. Liu and T. Zhou, *Two dimensional invisibility cloaking by transformation optics*, Discrete Contin. Dyn. Syst., **31** (2011), 525–543.
- [30] G. Menegatti and L. Rondi, *Stability for the acoustic scattering problem for sound-hard scatterers*, preprint, 2013.
- [31] G. W. Milton and N.-A. P. Nicorovici, *On the cloaking effects associated with anomalous localized resonance*, Proc. Roy. Soc. Lond. A, **462** (2006), 3027–3095.
- [32] J. C. Nédélec, *Acoustic and Electromagnetic Equations: Integral Representations for Harmonic Problems*, Springer-Verlag, New York, 2001.
- [33] A. N. Norris, *Acoustic cloaking theory*, Proc. R. Soc. Lond. A, **464** (2008), 2411–2434.
- [34] H. Nguyen, *Cloaking via change of variables for the Helmholtz equation in the whole space*, Comm. Pure Appl. Math., **63** (2010), 1505–1524.
- [35] H. Nguyen and M. S. Vogelius, *Full range scattering estimates and their application to cloaking*, Arch. Ration. Mech. Anal., **203** (2012), 769–807.
- [36] J. B. Pendry, D. Schurig and D. R. Smith, *Controlling electromagnetic fields*, Science, **312** (2006), 1780–1782.
- [37] L. Rondi, *Unique determination of non-smooth sound-soft scatterers by finitely many far-field measurements*, Indiana Univ. Math. J., **52** (2003), 1631–1662.
- [38] Z. Ruan, M. Yan, C. W. Neff and M. Qiu, *Ideal cylindrical cloak: Perfect but sensitive to tiny perturbations*, Phy. Rev. Lett., **99** (2007), 113903.
- [39] G. Uhlmann, *Visibility and invisibility*, ICIAM 07–6th International Congress on Industrial and Applied Mathematics, Eur. Math. Soc., Zürich, pp. 381–408, 2009.
- [40] M. Yan, W. Yan and M. Qiu, *Invisibility cloaking by coordinate transformation*, Chapter 4 of *Progress in Optics*–Vol. 52, Elsevier, pp. 261–304, 2008.